

Owner's Handbook
for Vehicle



**saloon
touring**

**520i
523i
525i
530i
535i
540i**

**520d
525d
530d**

Congratulations on your choice of a BMW.

The better you are acquainted with your car, the easier it will be to drive. We would therefore like to offer you the following advice:

This Owner's Handbook contains important information on operating and looking after your BMW. Please read it carefully before setting out in your new car, so that you are fully familiar with the technical advantages of your BMW. It also contains useful information on maintenance, to uphold both the car's operating safety and its full resale value.

There are other brochures providing supplementary information.

We wish you an enjoyable driving experience.

BMW AG

Contents

Initial overview

- Driving area 12
- Instrument panel 13
- Indicator and warning lights 17
- Steering wheel with multifunction buttons 20
- Warning triangle 21
- First-aid kit 21
- Refuelling 22
- Fuel grades 23
- Tyre pressures 24

Controls in detail

Opening and closing:

- Keys 32
- Central locking system 32
- Opening and closing
 - via the door lock 33
- Opening and closing
 - via the remote control 34
- Opening and closing
 - from the inside 37
- Luggage compartment lid/tailgate 38
- Rear window 40
- Luggage compartment/load area 43
- Alarm system 44
- Electric windows 45
- Sliding/tilt sunroof 47

Adjusting:

- Correct seated position 49
- Seats 49
- Seat adjustment, mechanical 50
- Seat adjustment, electric 51
- Head restraints 53
- BMW Active seat 53
- Seat belts 54
- Seat, mirror and steering wheel memory 55
- Seat heating 56
- Adjusting steering wheel 57
- Steering wheel heating 58
- Mirrors 58

Safety systems:

- Airbags 60
- Carrying children in safety 61
- Car Memory, Key Memory 64

Driving:

- Ignition switch 66
- Starting the engine 66
- Stopping the engine 68
- Handbrake 68
- Manual gearbox 69
- Automatic transmission with Steptronic 70
- Turn indicators/headlight flasher 72
- Wipers/rain sensor 73
- Cruise control 74

Everything under control:

- Distance recorder (odometer); outside temperature display 77
- Revolution counter 78
- Energy Control 78
- Fuel gauge 78
- Coolant thermometer 79
- Service Interval indicator 80
- Check Control 81
- Computer 84
- Multi-Information Display (MID) 85
- Digital clock in MID 86
- Computer in MID 89
- Telephone operation via MID 94

Technical features for journey comfort and safety:

- Park Distance Control (PDC) 101
- Automatic Stability Control plus Traction (ASC+T)/Dynamic Stability Control (DSC) 102
- Electronic Damping Control (EDC) 104
- Self-levelling suspension 105
- Tyre Pressure Control (RDC) 105

Lights:

- Side lights/low-beam (dipped) headlights 107
- Instrument lighting 108
- Headlight beam throw adjustment 108
- High beams/parking lights 109
- Fog lights 109
- Interior light/load-area light 110
- Reading lights 110

Controlled-temperature air for a pleasant interior climate:

- Air conditioning 111
- Automatic air conditioning 114
- Roller sun blind 119
- Auxiliary heater 120
- Independent ventilation control 120
- Remote control for auxiliary heater 121

Practical interior equipment:

- Integrated universal remote control 122
- Glove box 124
- Storage compartments 125
- Car phone 125
- Drinks can holders 126
- Front ashtray 126
- Cigarette lighter 126
- Rear ashtray 127

Loading and load-carrying:

- Through-loading system 128
- Ski bag 129
- touring:
 - Load area 132
 - Roller-blind cover 132
 - Protective net 132
 - Compartments in load area 133
- Load 135
- Roof rack 136
- Towing a trailer 137

Driving precautions:

- Running in 142
- Driving hints 142
- Anti-lock brake system (ABS) 143
- Brakes 144

Wheels and tyres:

- Tyre pressures 145
- Condition of tyres 145
- New tyres 146
- Wheel and tyre combinations 146
- Winter tyres 147
- Snow chains 147

Contents

Operation, maintenance

In the engine compartment:

- Engine compartment lid 148
- The engine compartment at a glance 149
- Washer fluid 150
- Engine oil 150
- Coolant 152
- Brake fluid 154

Maintenance:

- The BMW Maintenance System 155

Legal requirements and regulations:

- Rule of the road 156
- Technical modifications 156
- OBD socket 157

Minor repairs

Replacing parts:

- Toolkit 160
- Wiper blades 160
- Lights and bulbs 161
- Remote control for auxiliary heater 166
- Wheel-changing 167
- Thiefproof wheel studs 170
- Battery 171
- Fuses 172

Mutual aid:

- Mobile Service 173
- Starting with a flat battery 173
- Tow-starting, towing away 175

Technical data

- Engine data 180
- Fuel consumption, carbon dioxide/CO₂ emissions 181
- Dimensions 183
- Weights 185
- Performance 189
- Filling capacities 191

Index

From A to Z 194

Notes on this Owner's Handbook

We have tried to make all the information in this Owner's Handbook easy to find. The quickest access to a particular topic or item is by consulting the detailed alphabetical index at the end. Consult the first chapter for an initial overview of your car. The detailed list of contents on the preceding pages is intended to arouse your curiosity about your new BMW and encourage you to read this information carefully.

When the time comes to sell your BMW, please remember to hand over this Owner's Handbook; it is regarded legally as part of the vehicle.

If you have any queries, BMW Service will be glad to advise you.

Symbols used



indicates precautions that must be followed precisely in order to avoid the possibility of personal injury and serious damage to the vehicle. ◀



contains information that will assist you in gaining the optimum benefit from your vehicle and enable you to care more effectively for your vehicle. ◀



refers to measures that can be taken to help protect the environment. ◀

◀ marks the end of a specific item of information.

* identifies optional extras or specific national-market items of equipment, and also accessories.



identifies index entries which refer you to sections on minor repairs or maintenance tasks.



identifies systems or components which can either be activated or adapted to suit an individual driver's requirements ("Car Memory", "Key Memory"). See page 64.

However, certain systems can only be activated or adjusted by BMW Service. ◀

Your car

When you ordered your BMW, you chose various items of equipment. This handbook describes all models and equipment specifications which BMW offers within this particular model line.

This explains why the handbook may also contain details of items which you have not ordered. The differences can easily be identified by the asterisk * shown against optional extras.

If your BMW contains equipment that is not described in this Owner's Handbook (e.g. a car radio or telephone), supplementary operating instructions will be supplied and you are requested to study and comply with them.

Status at time of printing

The high safety and quality standards of BMW vehicles are maintained by unceasing development work on designs, equipment and accessories. Because of this, your car may differ from the information supplied in the Owner's Handbook. Nor can errors and omissions be entirely ruled out. You are therefore asked to appreciate that no legal claims can be entertained on the basis of the data, illustrations or descriptions in this handbook.



In cars with right-hand drive, some controls will be located differently from those illustrated in this handbook. ◀

For your own safety



Use only parts and accessory products which BMW has approved for your car. Parts and products which BMW has approved for your car have been checked for safety, function and suitability. BMW accepts product liability for them.

BMW cannot accept liability for parts or accessory products of any kind which it has not approved.

BMW is unable to assess each individual product of outside origin as to its suitability for use on BMW vehicles without safety risk. Nor can suitability be assured if a specific national permit (e. g. General Operating Permit) has been issued or if, for example, an official inspection authority (such as the German TÜV) has approved the product. These tests cannot always take into account the full range of operating conditions applicable to BMW vehicles and may therefore be inadequate.

In short, the functional efficiency or road safety of your BMW, and also its value, may be affected if its specification is altered by installing parts not approved for it. Original BMW parts and accessories, other BMW-approved products and competent advice on all related matters are obtainable from BMW Service. ◀

Symbol for components and assemblies



indicates vehicle components on which it is advisable to consult this Owner's Handbook.

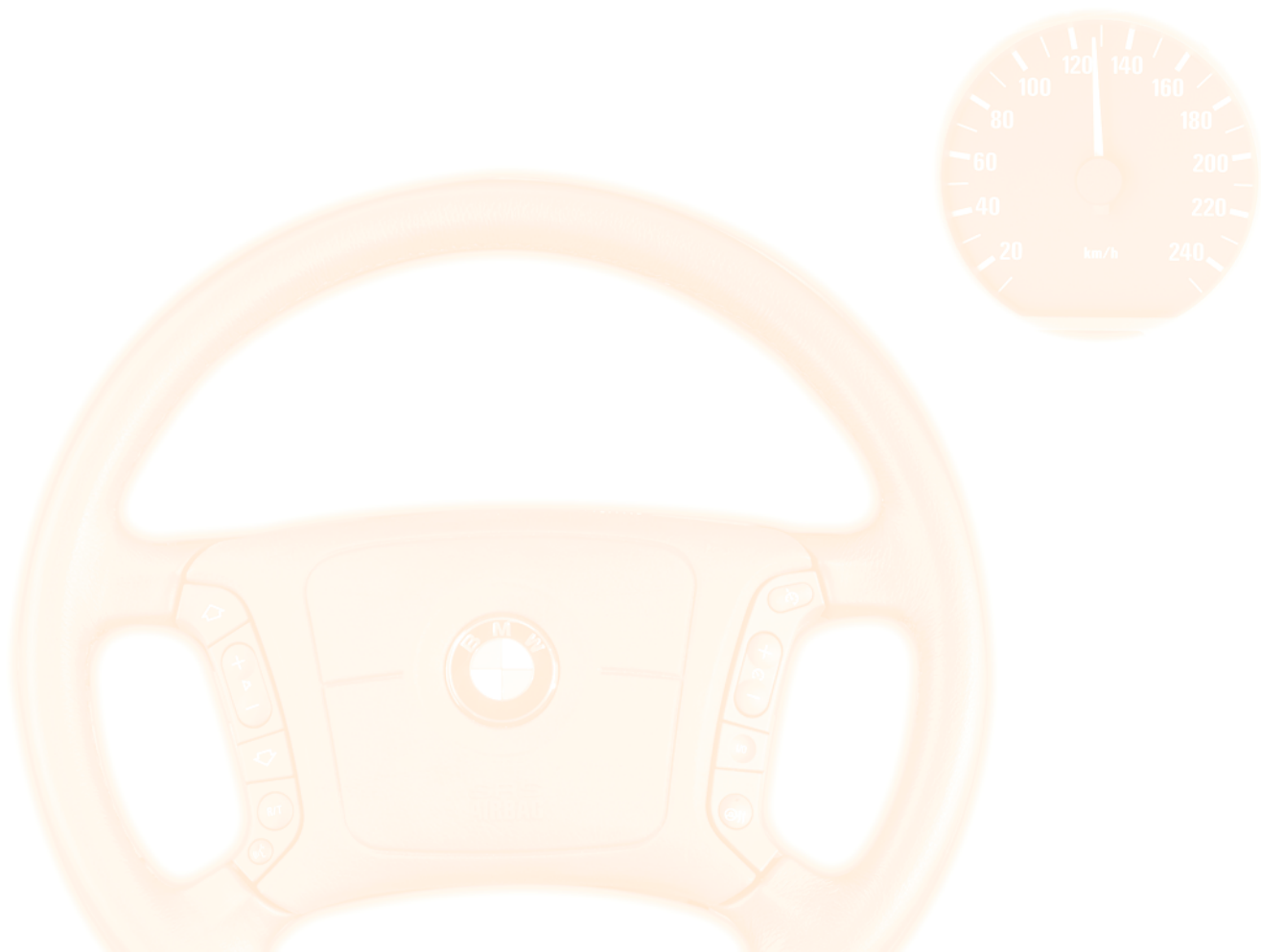



Initial overview

Controls in detail

Operation, maintenance

Minor repairs

Technical data

Index

Overview

Controls

Maintenance

Minor repairs

Data

Keywords

12 Driving area

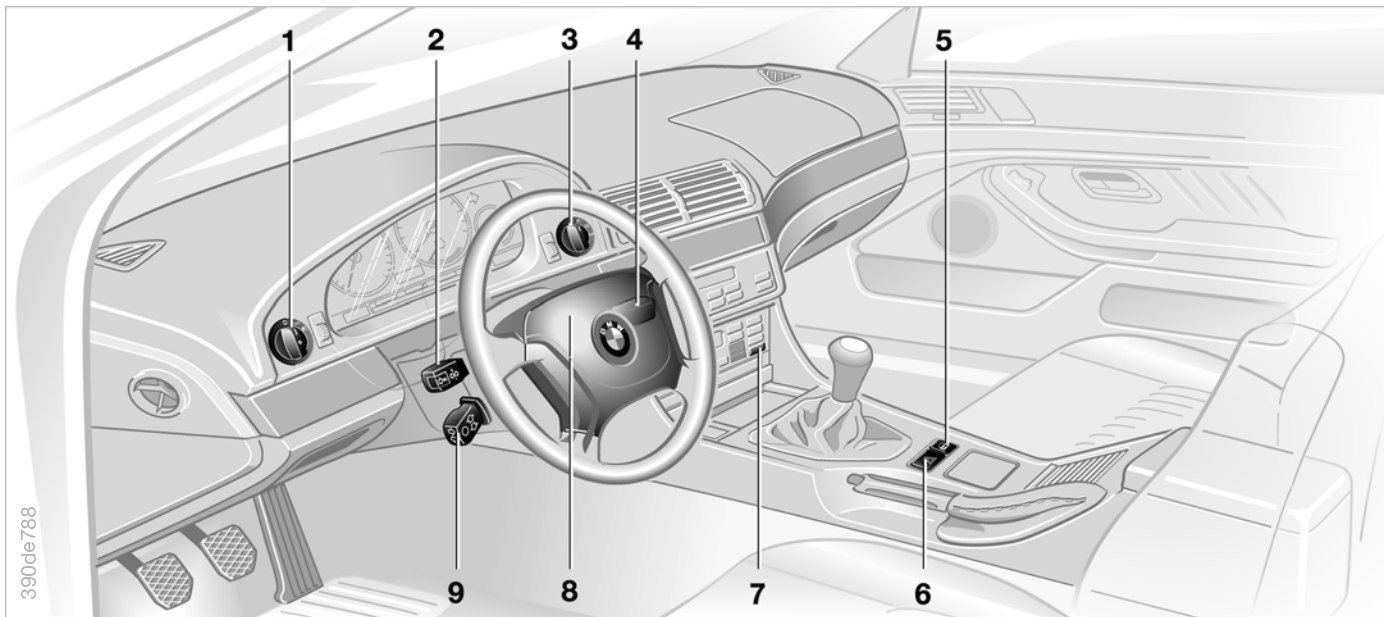

1 Side/parking lights 107

2 ▷ Turn indicators 72

▷ Parking lights 109

▷ High-beam headlights 109

▷ Headlight flasher 72

▷ Computer 84, 89

3 Fog lights 109

4 Wipers/washer 73

5 Central locking system 32

6 Hazard warning flashers

7 Heated rear window 112, 118

8 Horn, entire surface

9 Electric steering wheel
adjustment* 57

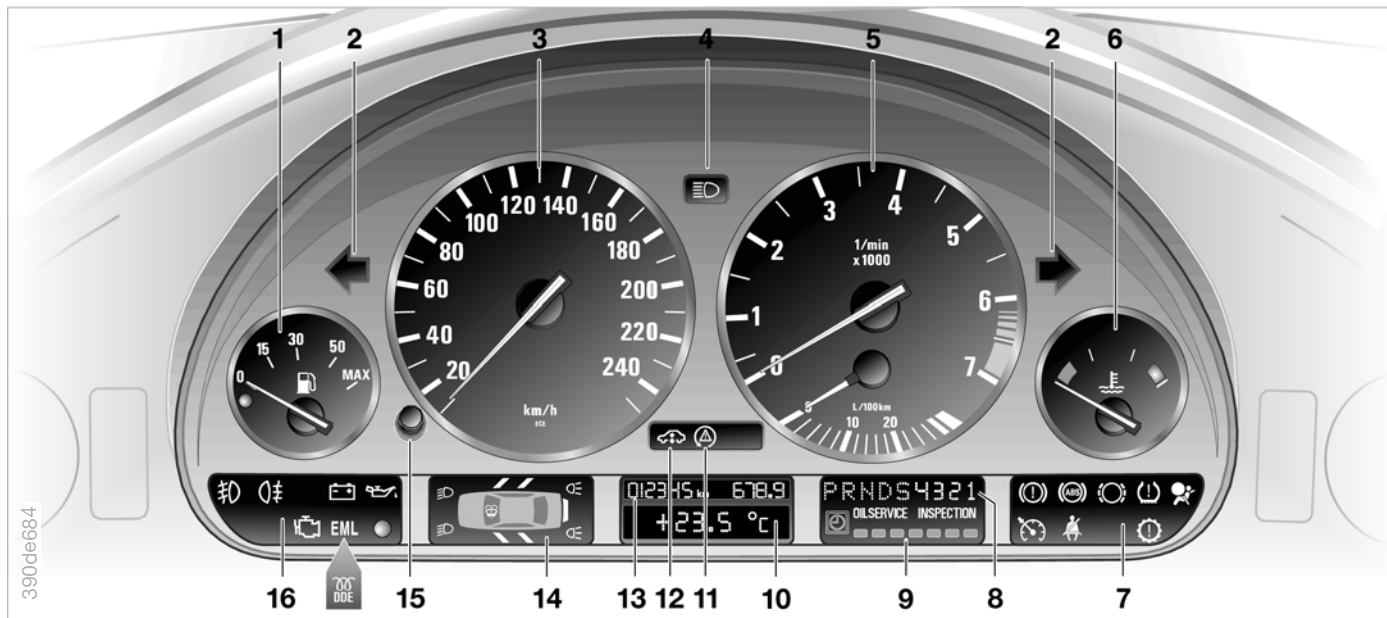

- | | | |
|--|---|---|
| 1 Fuel gauge 78 | 6 Coolant thermometer 79 | 10 Computer display – for operation from turn indicator lever, see page 84: |
| 2 Flashing turn indicator repeater 19 | 7 Indicator and warning lights 17 to 19 | ▷ Outside temperature |
| 3 Speedometer | 8 Automatic transmission* selector lever and program display 70 | ▷ Average fuel consumption |
| 4 High beam indicator light 19 | 9 Service Interval indicator 80 | ▷ Range before refuelling |
| 5 Revolution counter and Energy Control 78 | | ▷ Average speed |

14 Instrument panel



11 Indicator light for Automatic Stability Control plus Traction Control (ASC+T)/Dynamic Stability Control (DSC)* 18

12 Indicator light for self-levelling suspension* 19

13 Distance recorder (odometer) and trip distance recorder 77

14 Display for Check Control 81
 15 Trip distance control zeroing 77
 16 Indicator and warning lights 17 to 19



You can also have outside temperature and the distance covered displayed in another unit of measurement. ◀

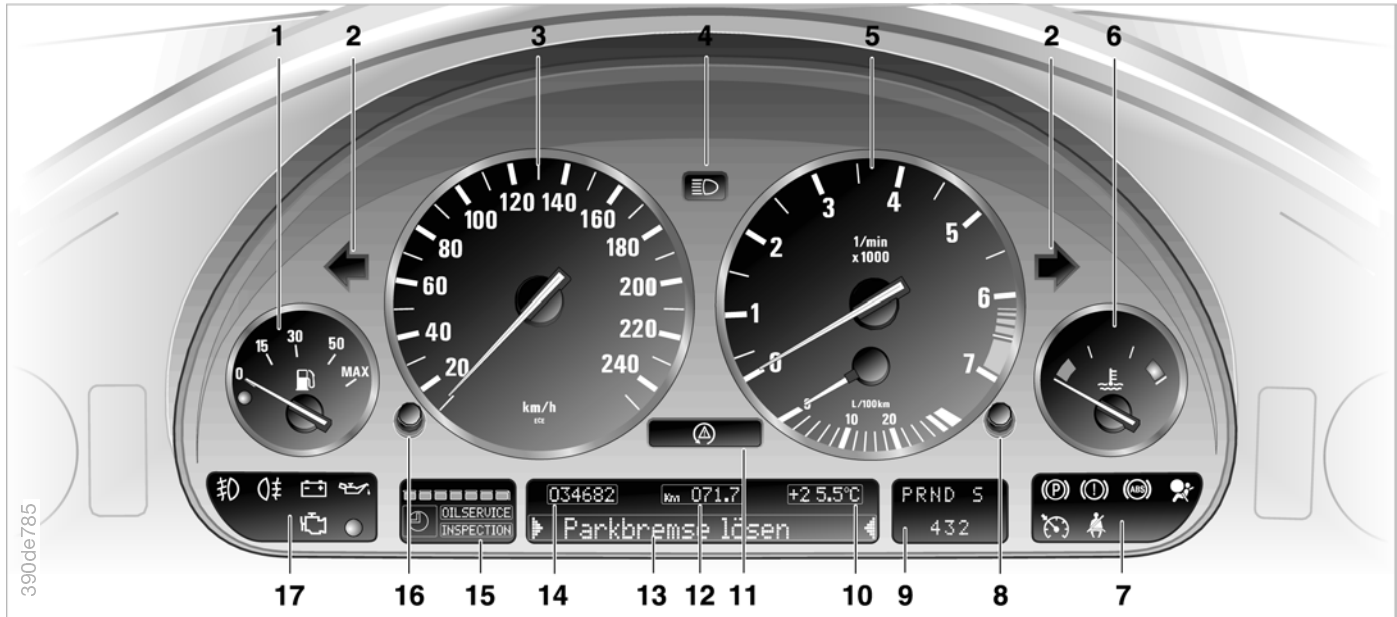

- | | | |
|--|---|--|
| 1 Fuel gauge 78 | 6 Coolant thermometer 79 | 10 Outside temperature display 77 |
| 2 Flashing turn indicator repeater 19 | 7 Indicator and warning lights 17 to 19 | 11 Indicator light for Automatic Stability Control plus Traction (ASC+T)/Dynamic Stability Control (DSC)* 18 |
| 3 Speedometer | 8 CHECK key 81 | |
| 4 High beam indicator light 19 | 9 Automatic transmission* selector lever and program display 70 | |
| 5 Revolution counter and Energy Control 78 | | |

390de785

16 Instrument panel*



- 12 Trip distance recorder 77
- 13 Check Control display 81
- 14 Odometer (distance recorder) 77

- 15 Service Interval indicator 80
- 16 Trip distance control zeroing 77
- 17 Indicator and warning lights 17 to 19



You can also have the outside temperature displayed in another unit of measurement or the Check Control messages and computer information shown in a different language. ◀

Indicator and warning lights

Technical equipment that monitors itself

The functioning of indicator and warning lights marked "●" is checked when the ignition is switched on. They come on once for varying periods.

If a fault occurs in one of the systems, the corresponding light will remain on when the engine is started or will come on again during the journey. The correct response to this on your part is described below.

Red: stop as soon as possible



Battery charge ●

The battery is not being charged. The alternator V-belt is defective or there is a fault in the alternator charging circuit. Consult the nearest BMW Service.



If the V-belt is defective, do not continue the journey, as there is a risk of the engine overheating and suffering damage. A defective V-belt also increases the effort needed to turn the steering wheel. ◀



Engine oil pressure ●

Possibly in conjunction with the display "STOP! ENGINE OIL PRESS" in the Check Control*: stop immediately and switch off the engine. Check engine oil level and top up if necessary. If the oil level is correct: consult the nearest BMW Service.



Do not continue the journey, as the engine may otherwise be damaged by inadequate lubrication. ◀



Tyre pressure control (RDC)* ●
A gong signal is also heard. The tyre is punctured or otherwise damaged. Immediately reduce speed and stop, avoiding violent braking and sudden steering wheel movements. Further details: page 105.



Brake hydraulics ●
If light remains on after releasing handbrake: have the brake fluid level checked. Before continuing your journey, read instructions on pages 144 and 154.

18 Indicator and warning lights

Red: important reminder



Handbrake* ●
Lights up when handbrake is applied.

Further details: page 68.



Handbrake* ●
Lights up when handbrake is applied.

Further details: page 68.

Also lights up when the message "CHECK BRAKE LININGS" appears in the Check Control.



Fasten seat belts ●
Depending on the version, a signal sounds at the same time*

or a message* appears in the Check Control display. Comes on for several seconds or, depending on version, until the seat belts are fastened.

Further details of seat belts: page 54.



Airbags ●
Have the problem examined by BMW Service.

Further details: page 60.

Yellow: have this checked soon



Anti-lock brake system (ABS) ●
ABS is switched off because a fault has developed. Normal brake action is not affected (no restrictions). Have the problem examined by BMW Service.

Further details: page 143.



Engine oil level*
If light comes on during journey: the engine oil is at its absolute minimum permitted level. Top up engine oil as soon as possible. Do not drive more than approx. 50 km (approx. 30 miles) before adding oil.

Further details: page 150.



Engine oil level*
If light comes on when engine is switched off: top up engine oil at next suitable opportunity (e.g. when refuelling).

Further details: page 150.



Automatic transmission* ●
A fault has caused the automatic transmission to switch to the emergency-run program. Please consult the nearest BMW Service.

Further details: page 72.



Brake pads* ●
Check the condition of your brake pads.

Further details: page 144.



Automatic Stability Control plus Traction (ASC+T)/Dynamic Stability Control (DSC)* ●

ASC+T/DSC has been switched off by pressing the control button, or due to a fault. If there is a fault, please have it checked by BMW Service.

Further details: page 102.



Dynamic Brake Control (DBC)* ●

Fault in DBC system. Normal brake action is not affected (no restrictions).

Have the system checked at the next opportunity by BMW Service.

Further notes on DBC: page 104.



Tyre pressure control (RDC)* ●
Check tyre pressures, see pages 24, 105.

Indicator and warning lights



Self-levelling suspension* ●
The self-levelling suspension is out of action. Please consult the nearest BMW Service.
Further details: page 105.



Engine ●
Deterioration of exhaust emission control values. Have the problem examined by BMW Service.



Engine electronics*
Fault in the engine electronics. The electronics will allow you to continue your journey at reduced engine output and engine speed. Have the problem examined by BMW Service.



Digital Diesel Electronics (DDE)* ●
If light comes on during journey: Have the problem examined by BMW Service.

Yellow: for your information



Rear fog lights*
Lights up when the rear fog lights are switched on.
Further details: page 109.



Diesel engine preheat* ●
Do not start the engine until the light has gone out.
Further details: page 67.

Green: for your information



Flashing turn indicators
Flashes rhythmically when a turn is selected; also applies to trailer if one is being towed. Rapid flashing: system malfunction.
Further details: page 72.



Cruise control*
Comes on when the system is switched on: ready to operate using the multifunctional steering wheel.
Further details: page 74.



Fog lights*
Lights up when the fog lights are switched on.
Further details: page 109.

Blue: for your information



High-beam headlights
Comes on when the high headlight beams are in use or the headlight flasher is used.
Further details: pages 72, 109.

20 Steering wheel with multifunction buttons

Integrated into the multifunctional steering wheel (MFL) and sports steering wheel are buttons to permit the following functions to be performed quickly and without the driver's attention being distracted from the traffic:

- ▷ Certain radio, CD, MD and tape cassette functions
- ▷ The air conditioning system's air recirculation mode or steering wheel heating* (MFL only)
- ▷ Cruise control
- ▷ Certain telephone functions* and
- ▷ Voice input*.



The systems in question must be switched on before they can be controlled. ◀



Press briefly:

To receive a telephone call, start to dial or terminate a call.

Keep pressed for a while:

To switch voice input on and off.

R/T

To change over between telephone and radio, cassette, CD or MD.



Forward:

- ▷ Radio
 - Press briefly: station search on "FM"
 - Keep pressed for a while: search run
- ▷ CD/MD
 - Press briefly: track search
 - Keep pressed for a while: searching within a track
- ▷ Cassette
 - Press briefly: title skip, or to halt fast forward
 - Keep pressed for a while: fast forward
- ▷ Telephone
 - Browse through phone book.



Reverse: functions as forward.



Volume control



Cruise control: calling up



Cruise control: memorise and accelerate (+), decelerate and memorise (-)

I/O

Cruise control: activate/interrupt/deactivate.



Recirculated air mode and Automatic Recirculated Air Control (AUC) or steering wheel heating: switching on and off

Warning triangle*

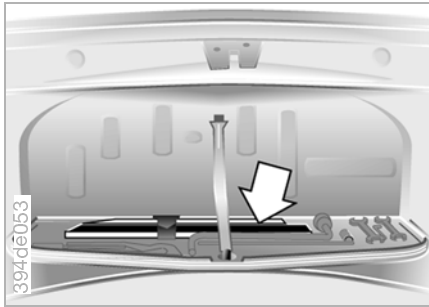

The warning triangle is kept in the tool holder in the luggage compartment lid or tailgate, and is easily reached when needed.

To open the toolkit, unscrew the wing bolt(s).

 Please note that you may be required by law to carry a warning triangle in the car. ◀

First-aid kit*



Under the front passenger's seat.

To remove: lift up the pushbutton catch at the front (arrow) and pull the first-aid kit forwards out of its holder.

To replace in position: insert the first-aid kit in its holder and push to the rear until the catch engages.

 Certain items in the first-aid kit have a limited useful life. Check the expiry dates of the various items regularly and renew them in good time: the items are available in any chemist. Comply with legal requirements concerning the need to carry a first-aid kit in the car. ◀

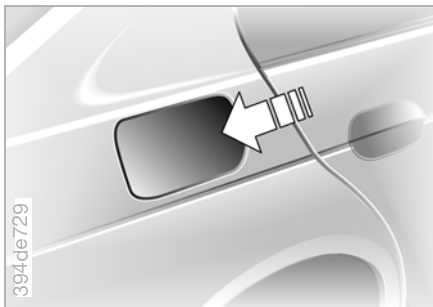

Fuel filler flap

To open, press in at the front edge.

In the event of an electrical fault, you can release the fuel filler flap manually as follows:

Saloon

1. Swing the right-hand side trim in the luggage compartment down by means of the handle at the top
2. Pull the button with the fuel pump symbol.

touring

1. Open the right-hand flap in the load area by pressing the button, and swing it down
2. Pull the button with the fuel pump symbol.

If a sub-woofer loudspeaker* is installed behind the right-hand flap, release the toggle screw and swing the sub-woofer to the side.



When handling fuel, comply with the safety regulations displayed by garages and filling stations. ◀

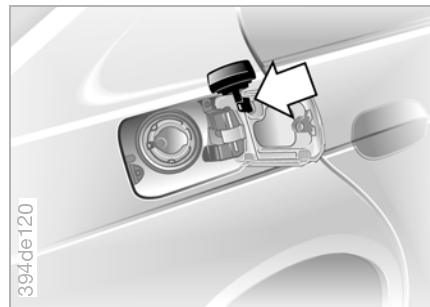

Simple and environment-friendly

Place the screw cap in the holder on the flap.

When refuelling, insert the filler nozzle fully into the filler neck. If the filler nozzle is raised during refuelling,

- ▷ The supply of fuel will be cut off prematurely
- ▷ Fuel vapour and fumes will be fed back less effectively.

The fuel tank is full when the filler nozzle cuts out for the first time, assuming it is being handled in the correct manner.



Do not run the fuel tank empty, to avoid damaging the catalytic converter. ◀

Refuelling

Closing the tank cap:

Fit the tank cap and turn clockwise until it is clearly heard to click into place (bayonet catch).

Fuel tank capacity: approx. 70 litres (approx. 15.4 Imp. gal.), including reserve capacity:

- ▷ with 4- and 6-cylinder engine: approx. 8 litres (approx. 1.8 Imp. gal.)
- ▷ with 8-cylinder engine: approx. 10 litres (approx. 2.2 Imp. gal.)

Fuel grade

Use unleaded fuel

The engine requires exclusively unleaded fuel, which may be of the ultra-low sulphur type. Since the engines have a knock control function, they can run on different grades of fuel.

Your BMW's engine is rated to run on:

- ▷ Super Plus/premium plus fuel (octane number 98, Research Method).

Fill up with petrol of this grade whenever possible, so that the nominal performance and fuel consumption values are achieved.

You can also run the engine on:

- ▷ Premium-grade unleaded fuel (octane number 95, Research Method).

This fuel is also known as: DIN EN 228 or Euro-Super.

The minimum permissible grade is:

- ▷ Regular-grade unleaded fuel (octane number 91 RON).

 Never use fuel containing lead, as the oxygen sensor and the converter will otherwise be permanently damaged. ◀

National-market versions supplied to run on leaded fuel*

In addition to the grades listed on the left, you can run the engine on leaded fuel. The minimum grade is likewise 91 RON.

Diesel engines

- ▷ Diesel oil to DIN EN 590 standard.

 Do not use rapeseed oil methyl ester (RME) or Biodiesel, or you risk damaging the engine. ◀

Winter-grade diesel

To ensure that the diesel engine operates reliably during the cold season of the year, it must be run on winter-grade diesel oil, which garages usually sell during the period in question. Fuel filter heating is installed as standard equipment to prevent the fuel from solidifying during operation.

 No additives may be used, as these could cause damage to the engine. ◀

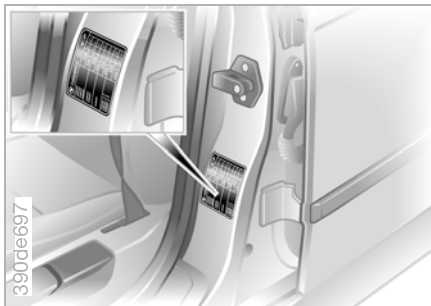

The tyre pressures are also displayed on the driver's door post (visible with the driver's door open).

Checking tyre pressures

All tyre pressures in the tables on the following pages are shown in the most common units of measurement bar (kPa/psi) for tyres at ambient temperature.

When towing a trailer, always use the values for the higher load.

Cars with Tyre Pressure Control (RDC)*:





After correcting tyre pressures, reactivate the system; see page 105.

 Check tyre pressures regularly (at least every two weeks and before starting a long journey). Incorrect tyre pressures can adversely affect the car's roadholding and cause tyre damage, which could result in an accident. Remember to check the spare wheel tyre pressure as well. The highest pressure needed for any of your car's tyres should be used as the pressure for the spare wheel. ◀







Make sure that only approved tyres are fitted

These tyre pressures apply to sizes and makes of tyre approved by BMW and known to BMW Service. If other makes of tyre are fitted to the car, higher tyre pressures may be needed.





Tyre pressures

BMW saloon	Tyre sizes	max. 			
	Tyre pressures in bar (kPa/psi)				
520i 520d 525d	205/65 R 15 94 V				
	225/60 R 15 96 V				
	225/55 R 16 95 V	2.0 (200/29)	2.3 (230/33)	2.4 (240/35)	2.9 (290/42)
	235/45 R 17 94 W/Y				
	Front: 235/45 R 17 94 W/Y	2.0 (200/29)	–	2.4 (240/35)	–
	Rear: 255/40 R 17 94 W/Y	–	2.3 (230/33)	–	2.9 (290/42)
	Front: 235/40 ZR 18	2.0 (200/29)	–	2.4 (240/35)	–
	Rear: 265/35 ZR 18	–	2.3 (230/33)	–	2.9 (290/42)
	205/65 R 15 94 Q/T/H M+S				
	225/60 R 15 96 Q/T/H M+S	2.2 (220/32)	2.5 (250/36)	2.6 (260/38)	3.1 (310/45)
225/55 R 16 95 Q/T/H M+S					
235/45 R 17 94 Q/T/H M+S					
523i 525i	225/60 R 15 96 W	2.0 (200/29)	2.4 (240/35)	2.4 (240/35)	2.9 (290/42)
	225/55 R 16 95 W				
	Front: 235/45 R 17 94 W/Y	2.2 (220/32)	–	2.6 (260/38)	–
	Rear: 255/40 R 17 94 W/Y	–	2.6 (260/38)	–	3.1 (310/45)
	Front: 235/40 ZR 18	2.2 (220/32)	–	2.6 (260/38)	–
	Rear: 265/35 ZR 18	–	2.6 (260/38)	–	3.1 (310/45)
	235/45 R 17 94 W/Y				
	205/65 R 15 94 Q/T/H M+S				
225/60 R 15 96 Q/T/H M+S	2.2 (220/32)	2.6 (260/38)	2.6 (260/38)	3.1 (310/45)	
225/55 R 16 95 Q/T/H M+S					
235/45 R 17 94 Q/T/H M+S					





26 Tyre pressures

BMW saloon	Tyre sizes	max. 			
	Tyre pressures in bar (kPa/psi)				
530i	225/55 R 16 95 W	2.1 (210/30)	2.5 (250/36)	2.6 (260/38)	3.1 (310/45)
	Front: 235/45 R 17 94 W/Y	2.3 (230/33)	–	2.8 (280/41)	–
	Rear: 255/40 R 17 94 W/Y	–	2.7 (270/39)	–	3.3 (330/48)
	Front: 235/40 ZR 18	2.3 (230/33)	–	2.8 (280/41)	–
	Rear: 265/35 ZR 18	–	2.7 (270/39)	–	3.3 (330/48)
530d	235/45 R 17 94 W/Y	–	–	–	–
	225/55 R 16 95 Q/T/H M+S	2.3 (230/33)	2.7 (270/39)	2.8 (280/41)	3.3 (330/48)
	235/45 R 17 94 Q/T/H M+S	–	–	–	–
	225/55 R 16 95 W	2.1 (210/30)	2.4 (240/35)	2.4 (240/35)	2.9 (290/42)
	Front: 235/45 R 17 94 W/Y	2.3 (230/33)	–	2.6 (260/38)	–
	Rear: 255/40 R 17 94 W/Y	–	2.6 (260/38)	–	3.1 (310/45)
	Front: 235/40 ZR 18	2.3 (230/33)	–	2.6 (260/38)	–
Rear: 265/35 ZR 18	–	2.6 (260/38)	–	3.1 (310/45)	
	235/45 R 17 94 W/Y	–	–	–	–
	225/55 R 16 95 Q/T/H M+S	2.3 (230/33)	2.6 (260/38)	2.6 (260/38)	3.1 (310/45)
	235/45 R 17 94 Q/T/H M+S	–	–	–	–

Tyre pressures

BMW saloon	Tyre sizes	max. 			
	Tyre pressures in bar (kPa/psi)				
	225/55 R 16 95 W	2.3 (230/33)	2.6 (260/38)	2.7 (270/39)	3.2 (320/46)
	Front: 235/45 R 17 94 W/Y	2.5 (250/36)	-	2.9 (290/42)	-
	Rear: 255/40 R 17 94 W/Y	-	2.8 (280/41)	-	3.4 (340/49)
535i	Front: 235/40 ZR 18	2.5 (250/36)	-	2.9 (290/42)	-
540i	Rear: 265/35 ZR 18	-	2.8 (280/41)	-	3.4 (340/49)
	235/45 R 17 94 W/Y				
	225/55 R 16 95 Q/T/H M+S	2.5 (250/36)	2.8 (280/41)	2.9 (290/42)	3.4 (340/49)
	235/45 R 17 94 Q/T/H M+S				

28 Tyre pressures

BMW touring	Tyre sizes	max. 			
Tyre pressures in bar (kPa/psi)					
520d	205/65 R 15 94 V	2.0 (200/29)	2.4 (240/35)	2.6 (260/38)	3.1 (310/45)
	225/60 R 15 96 V				
	225/55 R 16 95 V				
	235/45 R 17 94 W/Y				
520i	205/65 R 15 94 Q/T/H M+S	2.2 (220/32)	2.6 (260/38)	2.8 (280/41)	3.3 (330/48)
	225/60 R 15 96 Q/T/H M+S				
	225/55 R 16 95 Q/T/H M+S				
	235/45 R 17 94 Q/T/H M+S				
525d	225/60 R 15 96 V	2.0 (200/29)	2.4 (240/35)	2.6 (260/38)	3.1 (310/45)
	225/55 R 16 95 V				
	235/45 R 17 94 W/Y				
	205/65 R 15 94 Q/T/H M+S	2.2 (220/32)	2.6 (260/38)	2.8 (280/41)	3.3 (330/48)
525d	225/60 R 15 96 Q/T/H M+S				
	225/55 R 16 95 Q/T/H M+S				
525d	225/55 R 16 95 Q/T/H M+S				
	235/45 R 17 94 Q/T/H M+S				

Tyre pressures

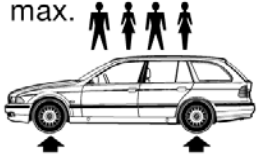
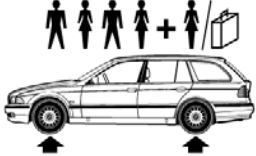
BMW touring	Tyre sizes				
	Tyre pressures in bar (kPa/psi)				
	225/60 R 15 96 W				
	225/55 R 16 95 W	2.1 (210/30)	2.5 (250/36)	2.6 (260/38)	3.1 (310/45)
	235/45 R 17 94 W/Y				
525i	205/65 R 15 94 Q/T/H M+S				
	225/60 R 15 96 Q/T/H M+S	2.3 (230/33)	2.7 (270/39)	2.8 (280/41)	3.3 (330/48)
	225/55 R 16 95 Q/T/H M+S				
	235/45 R 17 94 Q/T/H M+S				
	225/55 R 16 95 W				
530i	235/45 R 17 94 Y				
540i	225/55 R 16 95 Q/T/H M+S	2.4 (240/35)	2.8 (280/41)	2.8 (280/41)	3.3 (330/48)
	235/45 R 17 94 Q/T/H M+S				
	225/55 R 16 95 W	2.1 (210/30)	2.5 (250/36)	2.6 (260/38)	3.1 (310/45)
	235/45 R 17 94 W/Y				
530d	225/55 R 16 95 Q/T/H M+S	2.3 (230/33)	2.7 (270/39)	2.8 (280/41)	3.3 (330/48)
	235/45 R 17 94 Q/T/H M+S				



Initial overview

Controls in detail

Operation, maintenance

Minor repairs

Technical data

Index

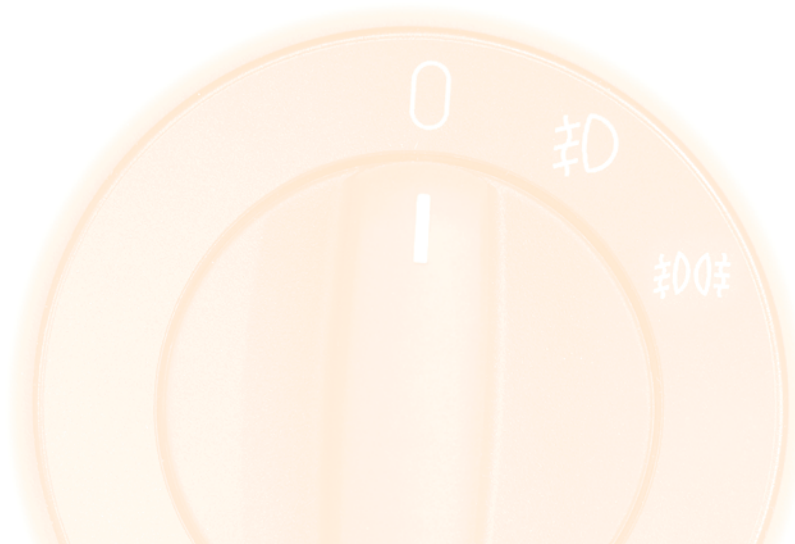

Overview

Controls

Maintenance

Minor repairs

Data

Keywords

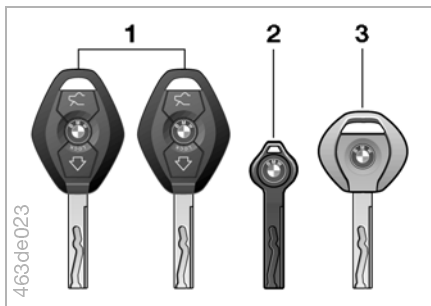

The set of keys

- 1 Master key with remote control:
For choice of Key Memory functions, see page 64
In conjunction with this, you can identify the keys with the coloured stickers supplied with the car

▷ Each master key contains a long-life battery that is automatically recharged while the car is being driven. For this reason, you should drive the car at least once a year for a significant distance using any master keys that have not been in regular use, so that their batteries can be recharged. See also page 35. ◀

- 2 Spare key, to be kept in a safe place, for instance in a purse or wallet. This key is not intended for regular use
- 3 Key for doors and ignition
This key does not open the luggage compartment lid/tailgate or the glove box – this can be useful for instance at a hotel or restaurant with car parking service

Central locking system

The principle

The central locking system cannot take effect until both front doors are closed. The following are unlocked and locked in combination:

- ▷ Doors
- ▷ Luggage compartment lid/tailgate and rear window*
- ▷ Tank flap.

The central locking system can be operated

- ▷ From outside the car at the door lock or with the remote control
- ▷ From inside using a button.

When operated from the outside, the deadlocks are engaged at the same time. This prevents the doors from being unlocked either at the safety lock buttons or door handles. The alarm system* is also activated or deactivated.

In the event of a collision, the central locking system is released automatically, but only at doors which were not locked separately by means of the inside buttons; see page 37. The hazard warning flashers and interior light are also switched on.

Opening and closing – via the door lock

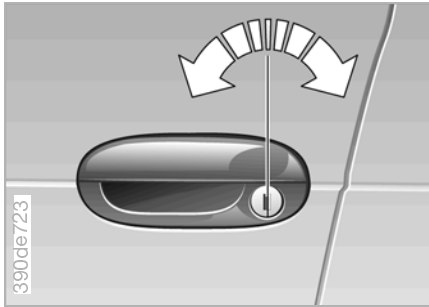

With the key



Do not lock the car when there is someone inside it, as it cannot then be unlocked from the inside. ◀



You can have a specific signal selected to confirm that the car has been locked properly. ◀



On certain national-market versions, the alarm system can only be operated by the remote control. On these cars, unlocking with a key triggers off the alarm.

To switch off the alarm:



Press the button (to unlock, see page 35) or turn the ignition key to position 1. ◀

For further details of the alarm system, see page 44.

Convenient operation

You can also operate windows and the sliding/tilt sunroof using the door lock.

- ▷ To open: when the door is closed, turn the key in the door lock to the release position and hold it there.
- ▷ To close: when the door is closed, turn the key to the locking position and hold it there.



Watch the closing movement to ensure that no-one is trapped. The movement is stopped when the key is released. ◀

Emergency operation

(in the event of an electrical malfunction)

By turning the key to the limit positions in the door lock, you can lock and unlock the driver's door.

34 Opening and closing – via the remote control

The principle

The remote control is an extremely convenient way to lock and unlock your car. It also has two additional functions that can only be operated from the remote control:

- ▷ Switching on the interior lighting, see page 36
This function enables you to locate the car, for instance in an underground garage.
- ▷ Opening the luggage compartment lid or tailgate, see page 36
Opens slightly regardless of whether the lid was previously locked or unlocked.

When the car is unlocked/locked, the deadlocks are also deactivated/activated, the alarm system* switched off/on, and the interior light switched on/off.



- 1 Unlocking, convenient opening and alarm system
- 2 Locking and deadlocking, convenient closing, switching on interior light, switching off tilt alarm sensor and interior movement detector
- 3 Opening luggage compartment lid or tailgate

 On certain national-market versions, the alarm system can only be operated by the remote control. On these cars, unlocking with a key triggers off the alarm. To switch off the alarm:



Press the button (to unlock, see page 35) or turn the ignition key to position 1. ◀

Opening and closing – via the remote control

Master key with remote control

 Persons remaining in the car or pets left inside can lock the doors from the inside. Always take the car keys with you so that the car can be opened from the outside. ◀

 Master keys in regular use are always operational because when they are in the ignition switch the battery they contain is automatically recharged while the car is being driven. If the car cannot be locked with the remote control, the battery in the key is flat. Use this key for a fairly long journey so that its battery is recharged. See also page 32.

To prevent unauthorised persons from gaining access to the remote control keys, hand over only door and ignition key 3 or spare key 2 (see page 32) to staff at a hotel or in a similar situation. In the event of faults, contact BMW Service. Replacement keys are also available from BMW Service. ◀

Unlocking



Press the button:

 On certain national-market versions, press the button twice, the first time to unlock the driver's door, the second time to release the remaining locks. ◀



If you wish, you can have this special arrangement programmed for each specific remote control. ◀

Convenient opening



Hold the button pressed. The windows and sliding/tilt sunroof open.

Locking and deadlocking



Press the button:

 Do not lock the car when there is someone inside it, as it cannot then be unlocked from the inside. ◀

Convenient closure:



Hold the button pressed. The windows and sliding/tilt sunroof will close.



Watch the closing movement to ensure that no-one is trapped. The closing procedure is interrupted if the button is released. ◀



You can have a specific signal selected to confirm that the car has been locked properly. ◀



On cars with an alarm system (see page 44): if the convenient closure movement is interrupted, the car must be unlocked again before convenient closure is undertaken again. Failing this, the tilt alarm sensor and interior movement detector will be out of action. ◀

To switch off the tilt alarm sensor* and interior movement detector*



Press the button again immediately after locking the car.

Further details: see page 45

Switching on the interior lighting



If the car is locked, press the button.

Opening the luggage compartment lid:



Press the button:

The luggage compartment lid opens slightly regardless of whether the lid was previously locked or unlocked.

 Before and after every journey, make sure that the luggage compartment lid has not been opened accidentally. ◀

Automatic tailgate operation* – touring

Opening the tailgate lid:



Press the button:

The tailgate lid opens completely, regardless of whether it was locked or unlocked.

If the button is pressed while the lid is opening, the opening process is interrupted.



The tailgate lid swings rearwards and upwards when opened. The upper edge of the tailgate is more than two metres from the ground when fully open. Make sure that there is sufficient clearance. ◀

Closing the tailgate lid:



Hold the button pressed.



Watch the closing movement to ensure that the lid closing movement is unobstructed and that no-one could be trapped.

The movement is stopped when the button is released.

If possible, drive only with the tailgate/luggage compartment lid and rear window fully closed, to prevent exhaust gases from entering the passenger compartment. If you are obliged to drive the car with the tailgate/luggage compartment lid or rear window open:

- ▷ Close all other windows and the sunroof
- ▷ Increase the air flow from the ventilation outlets or air conditioning considerably; see page 112 or 116. ◀

Interference

The remote control may be susceptible to local interference from other systems or equipment.

If this should occur, the car can be opened at the door lock or tailgate lock* with a master key.

Opening and closing – from inside

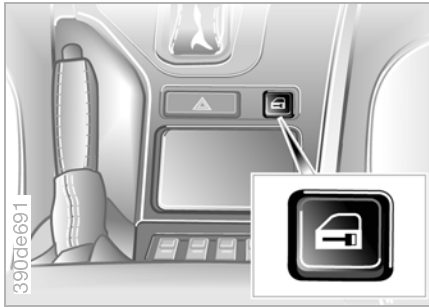

This button is used to operate the central locking system when the front doors are closed. This only unlocks or locks the doors, luggage compartment lid/tailgate and engine compartment lid – it does not activate the burglar alarm for them.



If you wish, the central locking system can be set to engage as soon as the car is driven away. You can have this setting programmed as part of the Key Memory facility. ◀

- ▶ If only the driver's door was unlocked with the remote control (see page 35) and you press the button,
 - ▶ All other doors, the luggage compartment lid/tailgate and the fuel filler flap will be released if the driver's door is open
 - ▶ The driver's door will be locked if it is closed. ◀

Unlocking and opening

- ▶ Either use the central locking button to unlock all doors at once, then pull the door handle above the armrest, or
- ▶ Pull the door handle twice at any door: the first time unlocks the door, the second time opens it.

Locking

- ▶ Either lock all doors at the central locking pushbutton, or
- ▶ Press the door safety buttons down. To avoid being shut out of the car accidentally, the driver's door cannot be locked with the safety button when it is open.



Do not lock the doors with the safety buttons during the journey, or else the central locking system will not be released in the event of an accident. Persons remaining in the car or pets left inside can lock the doors from the inside. Always take the key with you, so that the car can be opened from the outside. ◀

38 Luggage compartment lid/tailgate

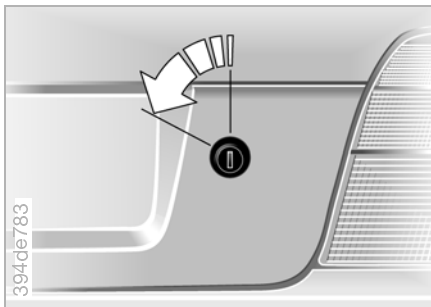

Lock – saloon only

Only the master keys (see page 32) fit the luggage compartment lid lock.

Opening separately

Insert a master key into the luggage compartment lock and turn it fully to the left – the lid will open slightly.

The luggage compartment is locked again as soon as its lid is closed.

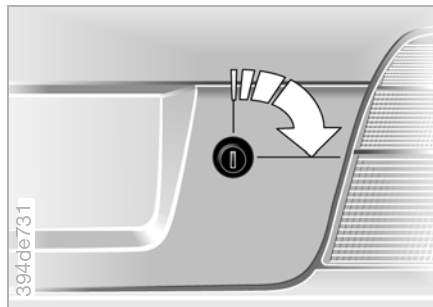

Locking separately

Turn the master key to the right past the pressure point and take it out when horizontal.

This locks the luggage compartment and disconnects it from the central locking system. If you then hand over only door and ignition key 3 (see page 32), the luggage compartment cannot be opened. This is an advantage, for example, at hotels.

Manual release

If an electrical defect occurs, you can operate the tailgate manually.

Saloon:

Insert a master key into the luggage compartment lid lock and turn fully to the left – the lid will open slightly.

The luggage compartment is locked again as soon as its lid is closed.

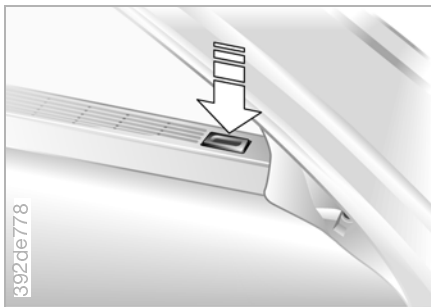

touring:

1. Working from the load area, open and take out the two side flaps (arrow)



2. In the tailgate, open the two quick-release fasteners for the toolkit cover and raise the cover
3. Take out the plastic plug (arrow) and pull towards the interior of the car to release the tailgate
4. Open the tailgate, press the plug back in and close the cover with the quick-release fasteners
5. Insert and close the two side flaps.

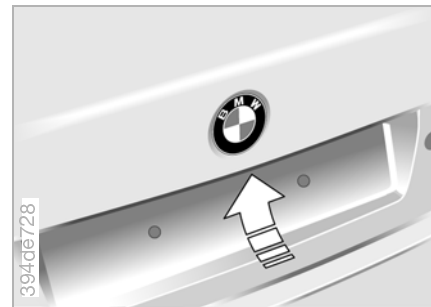

Opening from outside

Press the button (arrow): the luggage compartment lid/tailgate opens slightly.

The luggage compartment or load area is illuminated when you open the luggage compartment lid/tailgate (see also page 110).

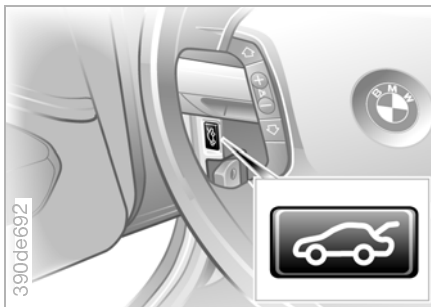

Opening from inside the car

With this button, you can open the luggage compartment lid/tailgate while the vehicle is stationary, provided it is not deadlocked.

 When the tailgate on the touring is open, its upper edge is more than two metres off the ground. Please remember this, for instance when opening the tailgate inside a garage.◀

For covering the load area and for other details of the load area, see "Load area", from page 132.

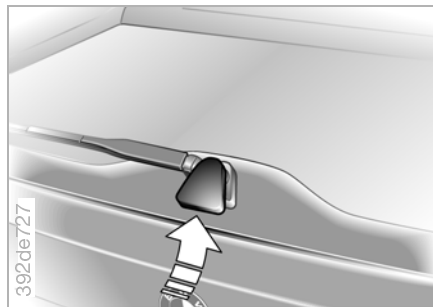

Rear window – touring

It is quick and easy to load and unload small items if the rear window is opened separately.

Press the button (arrow): the rear window opens slightly. It can be swung upwards.

To close the window, press down on the glass.

 Protect the window if it could be struck by sharp-pointed or sharp-edged objects on the load area during the journey; this is to prevent damage to the rear-window heating elements.◀

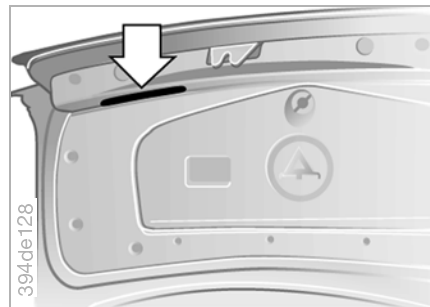

Closing – saloon

A recessed handle (arrow) next to the lock mechanism makes it easier to pull the lid down.

Luggage compartment lid/tailgate

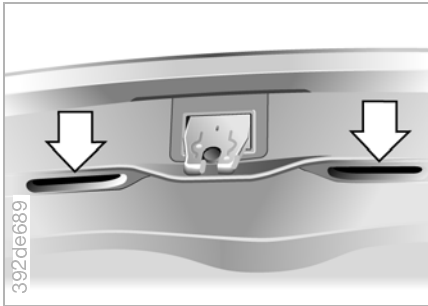

Closing – touring

You can pull the tailgate down with both hands if required (arrows) at the recessed handles provided.

To close the tailgate, press it down only lightly. The actual closing action is automatic.



To avoid injuries, as with any closing process, ensure that the closing area of the luggage compartment lid/tailgate is unobstructed. If possible, drive only with the tailgate and rear window fully closed, to prevent exhaust gases from entering the passenger compartment. If you are obliged to drive the car with the tailgate or rear window open:

- ▷ Close all other windows and the sunroof
- ▷ Increase the air flow from the ventilation outlets or air conditioning considerably; see page 112 or 116◀

Automatic tailgate operation* – touring

The tailgate opens completely if you press

- ▷ The button in the footwell (see page 40)
- ▷ The button in the handle (see page 39) or
- ▷ Button 3 on the remote control (see page 34).



The tailgate lid swings rearwards and upwards when opened. The upper edge of the tailgate is more than two metres from the ground when fully open. Make sure that there is sufficient clearance.◀

The tailgate closes automatically if you press

- ▷ The button on the inside of the tailgate (see next column)
- ▷ Button 3 of the remote control (see page 34) and hold it in.

Pressing one of these buttons interrupts the opening or closing movement immediately.

42 Luggage compartment lid/tailgate

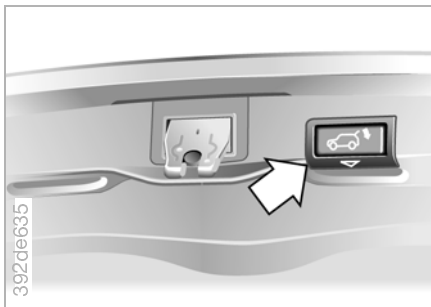

Closing:

With this button, you can close the tailgate completely.

If you press it again, you interrupt the closing process. This also occurs if you hold down the tailgate.

If you then press the button (or the one in the handle) again, the tailgate will re-open.

Emergency operation

(in the event of an electrical malfunction)

Release the tailgate manually (see page 39) and open and close it slowly, without sudden movements.



- To avoid injuries, as with any closing process, ensure that the closing area of the luggage compartment lid/tailgate is unobstructed. If possible, drive only with the tailgate and rear window fully closed, to prevent exhaust gases from entering the passenger compartment. If you are obliged to drive the car with the tailgate or rear window open:
- ▷ Close all other windows and the sunroof
 - ▷ Increase the air flow from the ventilation outlets or air conditioning considerably; see page 112 or 116. ◀

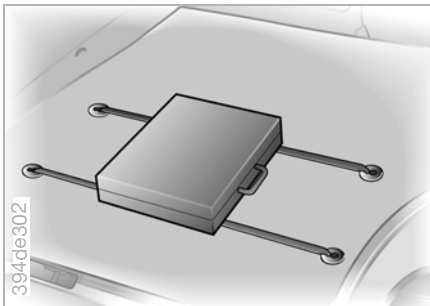

Tensioning straps

Use the tensioning straps on the floor of the luggage compartment to prevent small objects from slipping.

If you place objects on the lashing straps, they act as a non-slip base.

There are lashing points at the corners of the luggage compartment to which a net* or retaining straps can be attached when loads have to be secured.

See also under "Load", page 135.

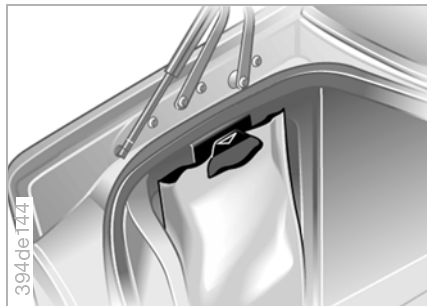

Hanger*

There is a hook on the left of the luggage compartment for hanging up carrier bags or similar.

The principle

The alarm system reacts if:

- ▷ A door, the engine compartment, the luggage compartment lid/tailgate or the rear window are opened
- ▷ There is any movement inside the car (interior movement detector)
- ▷ The car's angle changes, for instance if an attempt is made to jack it up and steal the wheels or to raise it prior to towing away
- ▷ There is an interruption in the power supply from the battery.

Depending on the national-market version of the car, the alarm system indicates unauthorised entry or tampering in different ways:

- ▷ 30-second acoustic alarm
- ▷ Switching on the hazard warning flashers for approx. five minutes*.

Activating and deactivating

Whenever the car is locked or unlocked, either at the lock or with the remote control, the alarm system is activated or deactivated at the same time.



You can arrange for various kinds of signal to be generated as confirmation that the system has been activated and deactivated correctly. ◀



Even if the system has been activated, you can open the luggage compartment lid/tailgate by pressing the remote control button (see page 36). When it is closed, the lid/tailgate is automatically protected again.



On certain national-market versions, the alarm system can only be operated by the remote control. On these cars, unlocking with a key triggers off the alarm.

To switch off the alarm:



Press the button (to unlock, see page 35) or turn the ignition key to position 1. ◀

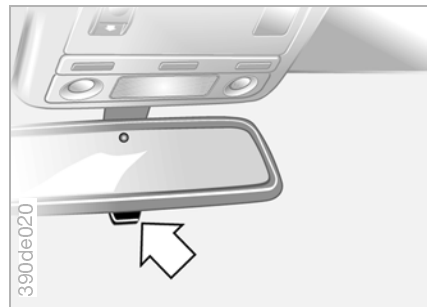

Alarm system indicator light

- ▷ If the indicator light under the inside mirror flashes steadily: the system is activated
- ▷ If the indicator light flashes when the system is being activated: not all doors, lids or the rear window are properly closed. Even if an item is not closed fully, the remaining items are protected and the indicator light begins to flash steadily after 10 seconds. However, the interior movement detector is not activated
- ▷ If the indicator light goes out when the system is deactivated, no attempt was made to tamper with the car during your absence

Alarm system*

- ▷ If the indicator light flashes for 10 seconds when the system is deactivated, an attempt was made to tamper with the car.

After the alarm has stopped, the indicator light once again flashes intermittently.

Avoiding unintentional alarms

The tilt alarm sensor and the interior movement detector can be switched off together. This prevents false alarms, for instance in two-level garages or when the car travels by train or ferry:

Lock (activate) the system twice, by pressing button 2 on the remote control twice in succession; see page 36, or perform the locking movement twice with the key; see page 33.

The indicator light comes on briefly, then flashes continuously. The tilt alarm sensor and interior movement detector are then switched off until the system is deactivated again.

Interior movement detector

Before the interior movement detector can operate correctly, the windows and sliding/tilt sunroof must be closed.

However, switch off the interior movement detector first (see previous column) if

- ▷ Children or animals remain in the car
- ▷ Windows or the sunroof are to remain open.

 The tilt alarm sensor and the interior movement detector will be switched off unintentionally if convenient closure of the windows and sunroof is interrupted during the first 10 seconds and then restarted. In this case the complete system must be deactivated and re-activated. ◀

Electric windows



Opening and closing windows

From ignition key position 1:

- ▷ Press the rocker switch in until the pressure point is felt:
The window continues to move for as long as the rocker switch is pressed
- ▷ Press the toggle switch beyond the pressure point:
The window then continues to move automatically.
Press the switch briefly again to halt the movement.

46 Electric windows

After the ignition is switched off:

- ▷ You can still operate the electric windows for up to 15 minutes, unless a front door was opened and closed again. To open, press the rocker switch beyond the pressure point.

 When leaving the car, always take out the ignition key and close the doors, so that children cannot operate the electric windows and possibly injure themselves. ◀

For convenient operation using the door lock or remote control, see page 33 or 35.

Protective function

There is a contact strip on the inside of each window surround at the top. If it is pressed as the window closes, the closing action is interrupted immediately and the window re-opens slightly.

 Despite this protective function, make sure that the window is not obstructed as it closes; if this precaution is not taken, the risk remains that thin objects, for instance, may not actuate the contact strip correctly. The protective function is switched off by pressing the switch beyond its normal pressure point and holding it there. ◀



Safety switch

This enables you to prevent the rear door windows from being opened and closed at the switches in the rear seat area, for instance by children.

 Always press the childproof safety switch when children are on the rear seat. Careless closure of electric windows can cause injury. ◀

Sliding/tilt sunroof

! Always close the sliding/tilt sunroof carefully, so that injuries are avoided.

When leaving the car, always take out the ignition key and close the doors, so that children cannot operate the electric windows and possibly injure themselves. ◀

For convenient operation using the door lock or remote control, see page 33 or 35.

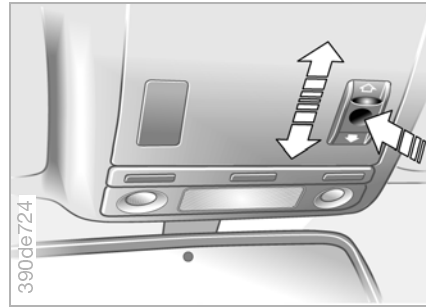

Raising – opening – closing

From ignition key position 1, press down the switch and/or slide in the desired direction up to the pressure point.

When being raised, the roof lining only retracts a few centimetres.

▷ The roof lining cannot be closed when the sliding/tilt sunroof is in the raised position. ◀

You can operate the electric sunroof for up to 15 minutes after switching off the ignition, provided that a front door has not been opened and closed again in the meantime.

Automatic* opening and closing

Press the button and hold it beyond the pressure point.

Further to this, the following movements are automated:

- ▷ When the roof is open, press the switch in the "Raising" direction: the roof moves to the limit position for "Raising"
- ▷ When the roof is raised, press the switch towards "Opening": the sunroof panel moves to the fully open position.

Pressing the switch stops this movement.

Protective function

If the sliding/tilt sunroof encounters resistance when closing with the roof roughly half closed, the closing operation is interrupted and the roof re-opens slightly.

! Despite this protective function, make sure that the roof is not obstructed as it closes; if this precaution is not taken, the risk remains that thin objects, for instance, may not actuate the closing-force limiter correctly.

The protective function is switched off by pressing the switch beyond its normal pressure point and holding it there. ◀

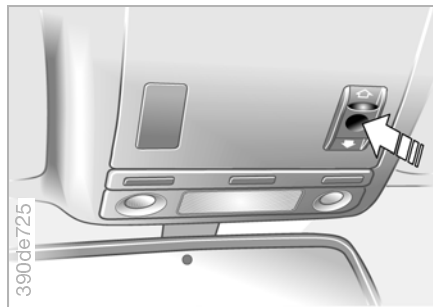

Sliding/tilt sunroof with glass panel*

Operation and function are as described above for the conventional sliding/tilt sunroof. To open the roof from the raised position, hold the switch in the opening direction until the roof has reached the desired position.

When the roof panel is raised, the sliding trim is pushed back slightly; when the roof is slid open, it moves with the roof panel. It remains in the opened position and can be slid if the roof is not completely open.

Interrupted power supply

If the electrical supply has been interrupted, for instance by disconnecting the car's battery, the roof will initially only perform a tilting movement. To restore its full range of functions:

1. Move the sliding/tilt sunroof to the fully raised position
2. Hold the switch down for approx. 20 seconds.

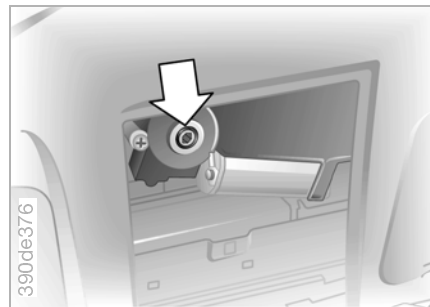

Emergency operation

In the event of an electrical defect, you can operate the sliding/tilt sunroof manually:

1. Take out the interior light, reach into the aperture and press out the cover
2. Use the Allen key from the car's toolkit (see page 160) to move the sunroof in the desired direction.

Correct seated position

A seated position that suitably reflects your requirements is a vital condition of relaxed, fatigue-free driving. In conjunction with the seat belts and the airbags, the correct seated position enhances the passive safety of the car's occupants in the event of an accident. You should therefore observe the following notes in order to maintain the protective function of the car's safety systems.

For additional notes on carrying children, see page 61.

Correct seated position in relation to airbags

 Keep your distance from the airbags. Always grip the steering wheel on the rim, to minimise the risk of injury to the hands and arms in the event of the airbag being triggered off. No other persons, pets or objects should be held or permitted to remain between the airbags and yourself. Do not use the front airbag cover on the front passenger's side as a tray, nor rest your feet or legs on it. ◀

The locations of the airbags and additional notes are given on page 60.

Safe travel with seat belt

 Only one person should be restrained by each seat belt; babies and small children must not travel sitting on the lap of an occupant of the car. The belts should not be twisted and must be positioned firmly over the pelvis and shoulder, as close to the body as possible. They should not pass over hard or fragile objects in your pockets. The seat belt must not run across the wearer's neck, nor should it be trapped or abraded by coming into contact with sharp edges or objects. Avoid bulky clothing and remember to tauten the lap belt frequently where it runs over the shoulder. In the event of a head-on collision, the lap belt could otherwise slide over the hips and injure the lower part of the body. In addition, the restraining effect is reduced if the seat belt is slack against the wearer's body. Pregnant women should also wear the seat belt, making sure that the lap strap is well down on the hips and does not press on the abdominal region of the body. ◀

For details of operating the seat belts, see page 54.

Seats

Before adjusting, note:

 Do not reposition the driver's seat while the car is in motion. The seat could move unexpectedly, leading to the driver losing control of the car, so that an accident could be caused. Do not recline the seat back too far when the car is being driven (this applies in particular to the front passenger), or there will be a risk of "submarining" under the seat belt, so that the belt loses its full protective effect. Do not slide the seats to the rear if the car is standing on a slope, for instance a ramp leading to a garage or a steep hill. This could lead to the automatic seat belt height adjuster becoming disconnected. ◀

Adjusting the seats

- ▷ Mechanical seat adjustment, see page 50
- ▷ Electric seat adjustment, see page 51
- ▷ Head restraints, see page 53
- ▷ BMW Active seat, see page 53

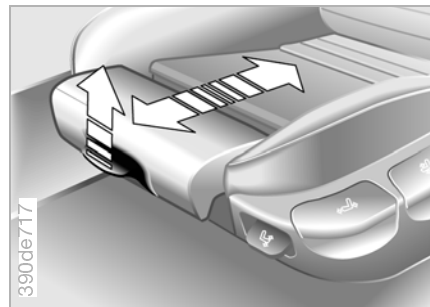
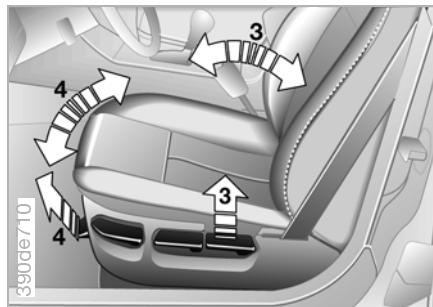
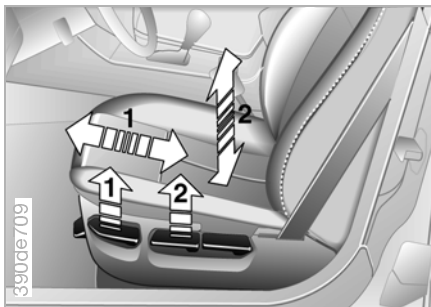

Seats, adjusting

1 Forward/back

Pull the lever up and slide the seat to the preferred position.

After releasing the lever, slide the seat backwards or forwards very slightly until it engages correctly

2 Height

Pull up the lever and apply your weight to the seat or allow it to rise

3 Seat back

Pull the lever and either apply your weight to the seat back, or lean forward to relieve it of load

4 Seat angle (driver's seat only)

Pull the lever up and move the seat to the desired angle



Comply with the adjusting instructions on page 49, or there may be a risk to your personal safety. ◀

Adjusting BMW Sport seat*

In addition, you can adjust the thigh support:

Pull the lever and move the thigh section until it provides the necessary support.

The angle of the passenger's seat can also be adjusted.

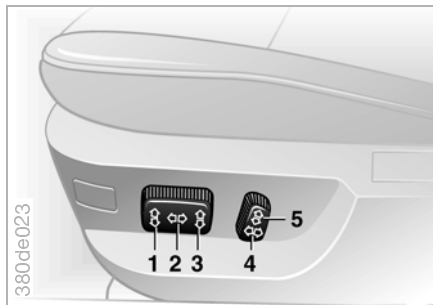

- 1 Seat angle (driver's seat only)
- 2 Forward/back
- 3 Height
- 4 Seat back
- 5 Head restraint height

Tilt the head restraint to alter its angle.



Comply with the adjusting instructions on page 49, or there may be a risk to your personal safety. ◀

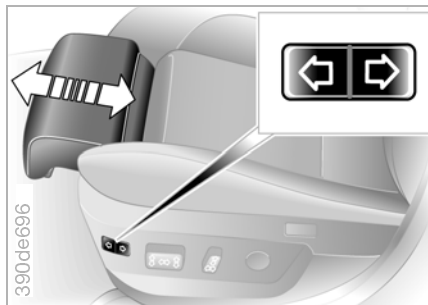

Adjusting BMW Sport seat*

In addition, you can adjust the thigh support:

Press the switch at the front or rear and adjust the position of the thigh support as preferred.

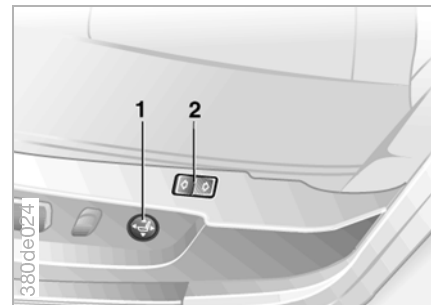

Adjusting BMW Comfort seat*

This seat has additional adjustment facilities for

- 1 Lumbar support
- 2 Shoulder support

Lumbar support:

The seat back contour can be altered to provide more support to the curved (lumbar) section of the spine.

The upper edge of the pelvis and the spinal column are supported, to encourage an upright but relaxed seated position.

52 Seat adjustment, electric*

- ▷ Push the switch forward or back: the curvature is increased or decreased.
- ▷ Press the switch at top or bottom: the curvature is increased at the top or bottom.



Shoulder support:

Push the switch forward or back: the angle of the upper part of the seat back changes.

The adjustable upper section of the seat back supports the shoulder area of the seat occupant's body. It enables a relaxed seat position to be found and reduces the load on the shoulder muscles.

To obtain the recommended optimum settings:

Driver's and front passenger's side:

1. Tilt the upper part of the seat back fully to the rear
2. Adjust to the most suitable position, as described on page 49

3. Tilt the upper section of the seat back forwards until adequate shoulder support is obtained.

Passenger's seat in rest position:

1. Tilt the upper part of the seat back fully to the rear
2. Set the seat angle to a slightly more upright position
3. Recline the seat back slightly more to the rear
4. Tilt the upper section of the seat back forwards until adequate shoulder support is obtained.



Correct the forward/back position of the seat if necessary to ensure that the seat belt still passes closely over the wearer's body, otherwise its protective action may be affected. ◀

Head restraints

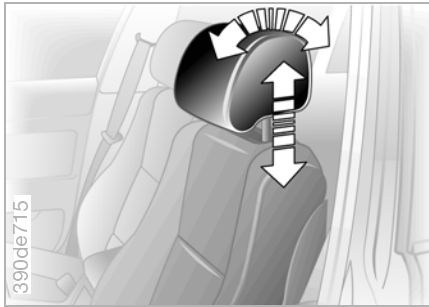

Adjusting

To adjust height: pull out or push in. Electric height adjustment, see page 51.

Adjusting front head restraint angle: swing forwards or back.



Head restraints reduce the risk of neck injuries in the event of an accident.

The head restraint should therefore be positioned with its centre at approximately the same height as the ears of the seat's occupant.

The centre rear head restraint should be left fully retracted; if it is pulled, it will not function correctly. ◀

BMW Active seat*

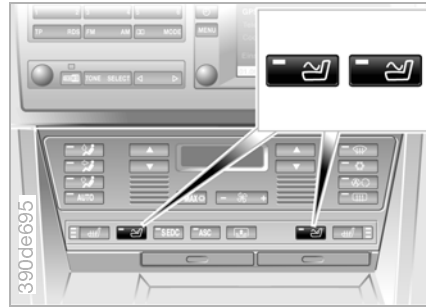

An active change to the seat surface helps to avoid strain, back pains in the lumbar region and signs of fatigue.

To activate, press the button.

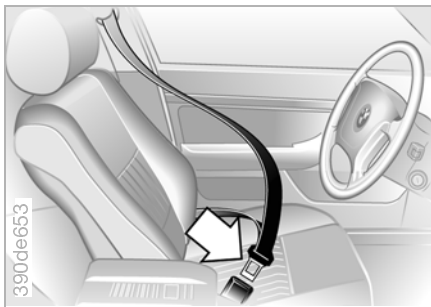

▶ The buckle marked "CENTER" is only to be used by a person occupying the centre rear seat. Saloon with through-loading system*: please note the instructions for the centre rear seat belt on page 128. touring: if the centre belt cannot be pulled out, the larger section of the rear seat back is not properly locked into position; see page 132. ◀

For your own safety

Always fasten your seat belt before every journey, despite the presence of an airbag: the airbags are a complementary safety feature, not a substitute for the seat belts.

To fasten

the seat belt buckle must be heard to engage.

To unfasten

1. Press the red button on the catch
2. Hold onto the belt
3. Guide the belt back up to the reel.

As the seat is moved forwards and back, the upper belt loop is automatically adjusted to the wearer's height.

⚠ If exposed to severe accident loads or damage: have the seat belt system renewed by BMW Service and the belt anchorages checked, otherwise their safety function can no longer be assured. ◀

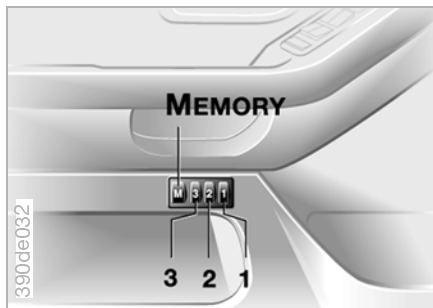

You can memorise and call up three different driver's seat, outside mirror and (with an electrically adjustable steering wheel) steering wheel positions. The picture shows the buttons on the driver's door.

The lumbar support settings are not memorised.

Memorising

1. Ignition key in position 1 or 2
2. Select the desired seat, outside mirror and steering wheel positions
3. Press the **MEMORY** button: the indicator light in the switch comes on
4. Press memory button 1, 2 or 3: the indicator light goes out.

Calling up

The convenient operating function:

1. With the driver's door unlocked and opened, or the ignition key turned to position 1
2. Press the appropriate memory button 1, 2 or 3 briefly.

The positioning movement is interrupted immediately if you operate a seat adjustment switch or one of the memory buttons.

The safety function:

1. Driver's door closed, ignition key either removed or in position 0 or 2
2. Press memory button 1, 2 or 3 until the adjusting procedure has been completed.

If the **MEMORY** button was pressed accidentally: press it again; the indicator light goes out.

 Do not call up the memory while the car is in motion, otherwise an unexpected seat or steering wheel movement may cause an accident. ◀



You can have your car programmed so that when it is unlocked with your own personal remote control your preferred seat, mirror and steering wheel positions are obtained automatically. ◀



If this Key Memory is used, make sure before unlocking that the footwell behind the driver's seat is unobstructed. Otherwise persons could be injured or damage caused if the seat moves back automatically to the previously selected position. ◀

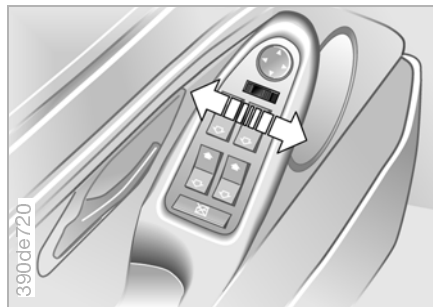

Passenger's side mirror tilt-down (parking position)

1. Move the mirror changeover switch (arrow) to the "driver's mirror" position
2. When reverse gear (or automatic transmission selector lever position R) is selected, the passenger's side mirror tilts down slightly. The road surface close to the car (for instance the kerb) is then in the driver's field of view, for instance while parking the car.

This automatic function can be switched off if not required: move the mirror changeover switch to the "passenger's side" mirror position.

Heated seats*

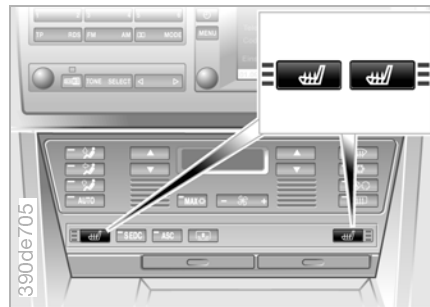

The seat cushion and seat back can be heated when the ignition key is in position 2. By pressing the button several times in succession, you can obtain different heat outputs.

Direct switching off is also possible when a higher heat output has been selected:
Keep the button pressed in for a longer period.

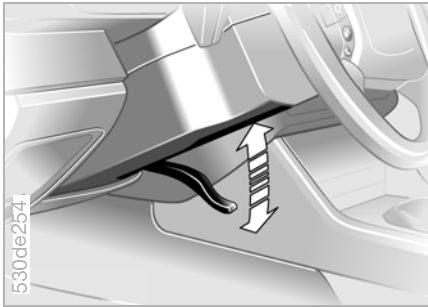

Manual

1. Swing out the clamp lever
2. Move the steering wheel to the preferred reach and angle to suit your seated position
3. Fold the lever back in to clamp the steering column in the new position.

 Do not adjust the steering wheel position while the car is in motion, or an accident may result from any unexpected movement. ◀

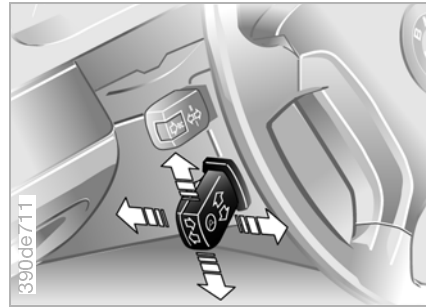

Electric*

The steering wheel can be repositioned in four directions, corresponding to the lever movements.

 Do not adjust the steering wheel position while the car is in motion, or an accident may result from any unexpected movement. ◀

To memorise steering wheel position, see "Seat, mirror and steering wheel position memory", page 55.

Automatic steering wheel adjustment

(only in conjunction with seat, mirror and steering wheel memory*)

To make it easier to get in and out of the driver's seat, the steering wheel automatically rises into its uppermost position before returning to the driving (memory) position.

This automatic system responds to the ignition key setting and the driver's door.



The steering wheel heating is operational in ignition key position 2.

To switch on and off, press the button.

When the steering wheel is being heated, the indicator light in the button is on.

If your car has a multifunctional steering wheel without steering wheel heating, this position is occupied by the recirculated air button (see page 20).

Mirrors

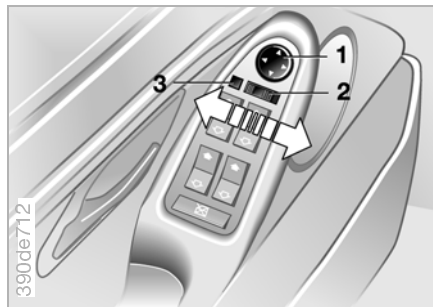

Outside mirrors

- 1 Switch for adjustment in all four directions
- 2 Changeover switch for mirror on other side of car
- 3 Button* for folding the mirrors in and out

Press button 3 once to fold the mirrors in and again to fold them out. This can for example be useful in car washes or narrow streets, or to fold the mirrors back out into the correct position after they have been folded in.



The mirrors can be folded in at road speeds of up to approx. 10 km/h. ◀

Adjusting manually

The mirrors can also be adjusted manually: press the mirror glass at its edges.

To memorise mirror positions, see "Seat, mirror and steering wheel position memory", page 55.

Convex mirror*

The outer, aspherically curved section of the mirror displays a larger field of view, though slightly distorted, than the inner, convex section. In this way, the view to the rear is extended and the blind spot, as it is known, is reduced in size.



The mirror on the front passenger's side is convex and therefore reflected objects are closer than they appear. It may be difficult to estimate the precise distance at which another vehicle is following your car. The same applies to the aspherical outer section of the mirrors. ◀

Electric mirror heating

Both mirrors are heated automatically in ignition key position 2.

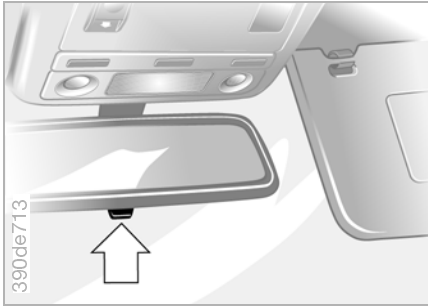

Inside mirror

To reduce glare from following vehicles after dark, tilt the mirror image by moving the small lever.

Cars with alarm system*:

Twist the knob on the underside of the mirror.

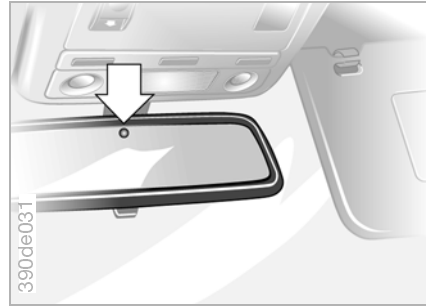

Inside and door mirrors, automatic-dip*

These mirrors are dipped automatically and revert automatically to the clear, non-dimmed position when you engage reverse gear or select R.

There are two photo-cells in the inside mirror for this purpose. One photo-cell is in the mirror glass (arrow), the other slightly offset on the back of the mirror.

To ensure that the mirrors operate correctly, keep the photo-cells clean and do not place any obstructions (including stickers or permits) between the inside mirror and the windscreen.

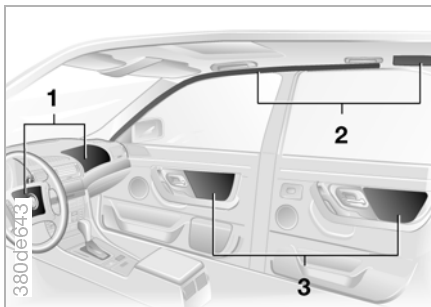



- 1 Front airbags on the driver's and front passenger's side
- 2 Head-level airbags on the driver's and front passenger's side (for front and rear*)
- 3 Side airbags on the driver's and front passenger's side (front and rear*)

Protective effect

The front airbags protect the driver and front passenger in the event of a frontal crash, if the protective action of the seat belts alone would be insufficient. The head-level and side airbags provide protection in the event of a side-on collision. The side airbag which inflates has the effect of supporting the upper body from the side.

For details of the correct seated position, see page 49.

 The airbags are not triggered off in minor accidents, nor if the car rolls over or is struck from the rear. ◀

 Never attach any material to the airbag covers with adhesive, place material over them or modify them in any way. Do not dismantle the airbag occupant restraint system. If the airbag occupant restraint system develops a fault, is shut down out of use or has been triggered off in an accident, have it checked, repaired or dismantled only by BMW Service. Never make any modifications to the individual components of the system or its wiring. This includes the upholstered covers on the steering wheel, instrument panel, side panels on front and rear doors and roof struts as well as down the sides of the roof liners. Do not remove the steering wheel. In order to comply with valid safety regulations, have airbag generators scrapped only by BMW Service. Any careless or unskilled interference with the system could lead to its failure or to accidental triggering off with the risk of injury. Avoid touching the

system's components immediately after it has been triggered off, as there is a risk of sustaining burns. ◀

Even if all these instructions are complied with, injury to the face, arms or hands as a result of the airbag inflating cannot be entirely ruled out, depending on the circumstances in which an accident occurs. If the car's occupants are unduly sensitive to the ignition and inflation noise generated by the airbag systems, their hearing may be temporarily affected.

Airbags

Indicator light



The indicator light in the instrument panel confirms that the airbag system is ready to operate (from ignition key position 1 onwards).

System operational:

- ▷ The indicator light comes on briefly and then goes out.

System defective:

- ▷ The indicator light does not come on, or
- ▷ The indicator light comes on briefly, goes out briefly and then comes on again.

In the event of a fault, have the system checked without delay by BMW Service, otherwise there is a risk that the airbags will not be triggered off even if a sufficiently severe accident occurs within the airbag range.

Carrying children in safety

For children up to 12 years of age and less than 150 cm (approx. 5 ft) tall, suitable approved restraint systems may have to be installed; comply with local regulations.

Small children up to about 18 months old can be secured with a rear-facing restraint system on the back seats, using standard seat belts.

BMW Service can supply suitable child restraint systems for every age group. Please comply with the notes in the installation instructions when using these products.



All the seats of your BMW, except for the driver's seat, are suitable for the installation of universal child restraint systems for all age groups, provided these have been approved for the age group in question. ◀



Do not allow children to travel on the front passenger's seat, including when sitting on the lap of another person or wearing a child restraint system, as there is the risk of injury if the airbags are triggered off. BMW Service can provide information on the temporary disabling of the

airbags on the front passenger's side and on changing the belt system on the front passenger's side.

Under no circumstances are child restraint systems to be modified, as their protective effect may otherwise be impaired.

If the car has rear side airbags, make sure that any child's seat is installed correctly and not too near the airbags in the door trim panels. Do not allow the child to lean out of the child's seat towards the door trim, as serious injuries could occur if the airbag were to be triggered off.

Observe the notes on installation and use provided by the manufacturer of the child restraint system, to uphold its protective effect. If damaged or subjected to strain in an accident, have the child restraint system and possibly the belt system used to secure it, together with other accessory items, renewed by BMW Service and the belt anchorages checked. ◀

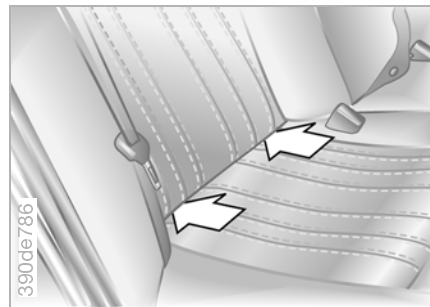
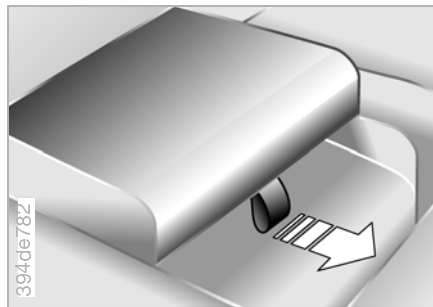
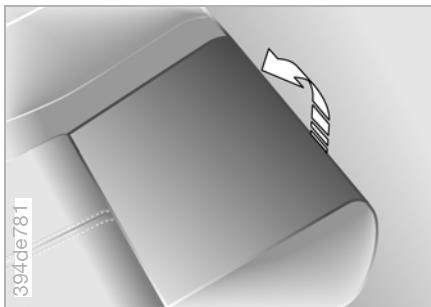

Integral child's seat*

These child's seats, in the two outer rear seat positions, satisfy the legal requirements of ECE Directive R-44 and are suitable for children between about 3½ and 12 years of age (weighing 15 to 36 kg (33 to 80 lbs)). For children from approx. 18 months to 3½ years of age (weighing 9 to 18 kg (20 to 40 lb)), use these seats in conjunction with the Comfort seat back and impact-absorbing table; these are available from BMW Service.

Unfolding the child's seat:

Reach under the front of the car's rear seat and pull it diagonally up and to the rear (arrow). Then press the child's seat to the rear until it engages in position.

Folding away the child's seat:
Release by pulling the loop forwards and down (arrow). Then press down from the top until the child's seat engages.

 Use the integral child's seats only in conjunction with the head restraints.

When repositioning the car's front seats, make sure that the child's feet are not trapped.

Never leave children in the car on their own – even when occupying a child's seat. ◀

ISOFIX child seat mounts* – saloon

The ISOFIX child seat mounts are located at the points marked with the arrows, which are not visible from the outside.

The illustration shows the rear right seat by way of an example.

Engage the centre rear seat belt in the catch marked "CENTER" and pull the belt away from the child seat mounts.

 Cars with through-loading system*: connect both sections of the centre belt with the small connecting catch, see page 128. ◀

Carrying children in safety

Carefully press the holders through the parting lines in the cushions at the marked points.

 For details of installing the ISOFIX child's seat system, please consult the separate operating and safety instructions supplied by its manufacturer. ◀



To avoid damaging the cushions, BMW Service is able to supply an insertion aid* (funnels).

Press this insertion aid firmly into the parting line between the base cushion and seat back, so that the two funnels engage on the ISOFIX brackets in the seat.

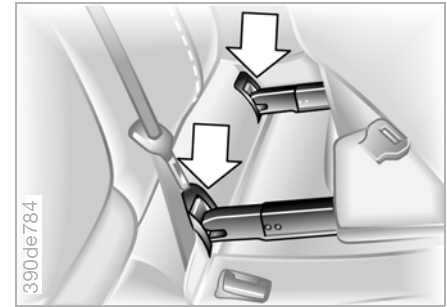

ISOFIX child seat mounts* - touring

Introduce the child seat catches into the mounts in the rear seat (arrows) and push the seat as far back as it will go.

The illustration shows the rear left seat by way of an example.

 For details of installing the ISOFIX child's seat system, please consult the separate operating and safety instructions supplied by its manufacturer. ◀

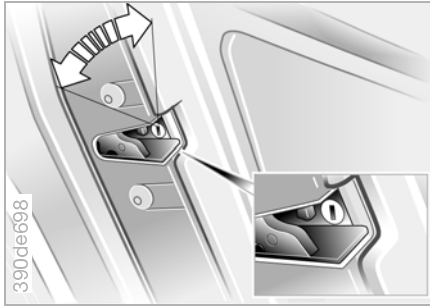

Childproof door locks

Insert key into slot on rear door and turn outwards.

This door can now only be opened from the outside.

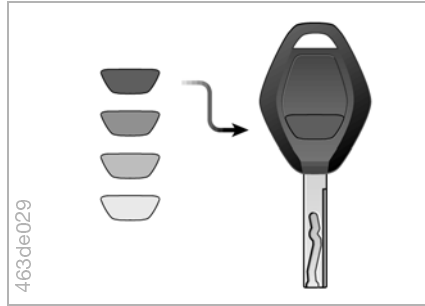

How it works

You have probably wished at times that individual functions of your car could be individually selected or adjusted to suit your own personal preferences. When developing the car, BMW therefore "designed in" a number of freely programmable options for the car, which BMW Service will gladly adjust as you wish.

There are "Car Memory" and "Key Memory" settings, the former relating to the car itself, the latter to your personal requirements. You can have two different basic settings selected if two people regularly drive the car. This presupposes that each person has his or her own remote control key.

By means of data exchange with the key, the car identifies the user when the car is unlocked and performs the necessary adjustments.

Coloured adhesive labels are supplied with the keys so that they can be identified by the users.

Car Memory, Key Memory

What can be selected

BMW Service will gladly inform you of the facilities available with Car Memory and Key Memory. A few examples are given below.

Examples for Car Memory:

- ▷ Various signals to confirm that the car has been locked/unlocked
- ▷ Deactivating/activating the headlight courtesy delay feature
- ▷ Activating/deactivating the daytime driving lights.
- ▷ Adjusting the units of measurement for the display of outside temperature and distance driven on the instrument panel.

Examples for Key Memory:

- ▷ Locking the vehicle after setting off
- ▷ Automatic adjustment of the driver's seat, door mirror and steering wheel position to the key user's preferred settings when the car is unlocked
- ▷ When unlocking, releasing first the driver's door, then the entire vehicle.



At the appropriate points in this Owner's Handbook you will find this symbol, as an indication that special settings as described above are available. ◀

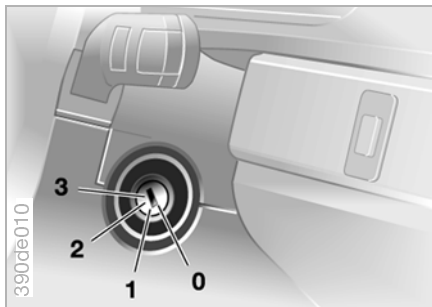

- 0 Steering locked
- 1 Steering released
- 2 Ignition switched on/
BMW 520d, 525d, 530d: preheating
- 3 Starting the engine

Steering locked

The key can only be inserted and removed in this position.

After removing the key, turn the steering wheel slightly if necessary until the steering lock engages.

After the ignition has been switched off (ignition key turned back to position 0 or removed), the radio functions will remain available for approximately 20 minutes. Switch the radio back on for these functions.

 Automatic transmission cars: do not move the selector lever away from position P until the engine is running (ignition key position 2). Before the ignition key can be returned to position 0 or pulled out, the automatic transmission selector lever must be moved to position P (interlock).◀

Steering released

A slight movement of the steering wheel often makes it easier to turn the key in the ignition from 0 to 1. Individual electrical consumers can then operate.

Starting the engine

Before starting

- ▷ Apply the handbrake
- ▷ Move the gear lever to neutral (or automatic transmission selector to P)
- ▷ At low temperatures, depress the clutch pedal.

 Never run the engine in an enclosed space. The exhaust gas contains carbon monoxide, which is colourless and odourless, but highly toxic. Inhaling exhaust gas constitutes a severe health risk and can lead to loss of consciousness with fatal consequences.

Do not leave the car unattended with the engine running, as it then constitutes a considerable potential hazard.◀

Starting the engine

Cars with spark-ignition engine

Do not press the accelerator pedal while starting the engine.

 Allow the starter motor to run for a reasonable time, but for no more than about 20 seconds. As soon as the engine fires, release the ignition key. BMW 535iA, 540iA:

Your BMW is equipped with a convenient-start system. It is sufficient to turn the ignition key briefly to position 3 (to operate the starter motor), then to release it.

The starter then runs automatically for a predetermined period, and cuts out as soon as the engine has started.

If the battery voltage is low, automatic starting cannot be activated, or the function is interrupted. The engine can be jump started (see page 173). ◀

Do not warm up the engine with the car at a standstill; it is preferable to set off straight away, driving at moderate engine speeds.

If the engine does not start at the first attempt, for instance when it is extremely hot or cold:

▷ Depress the accelerator pedal halfway while starting the engine.

Cold starts at very low ambient temperatures (below approx. -15°C) at high altitude (more than 1,000 m (approx. 3,250 ft) above sea level):

▷ On the first occasion, take longer over the starting operation (approx. 10 seconds)

 Excessively lengthy or frequent operation of the starter motor at short intervals can result in damage to the catalytic converter. ◀

 Make sure that when driving the car, standing with the engine running or when parking, no easily flammable material (hay, grass, leaves etc.) comes into contact with the hot exhaust system. It could ignite and cause a fire, with the risk of severe injuries or damage. ◀

Cars with diesel engine

When the engine is cold:

▷ Hold the ignition key in position 2 until the preheat indicator light or display goes out

▷ Start the engine.

At extremely low temperatures, the starter motor may have to be run for up to 40 seconds.

When the engine is warm:

▷ The preheat indicator light or display does not come on. Start the engine immediately.

Movement of the accelerator pedal has no influence on the starting process.

Do not allow the engine to warm up at a standstill, but drive off as soon as possible, using moderate engine speeds.

Bleeding the fuel system: even if the fuel tank has been run dry, the fuel system does not normally need to be bled.

If you nevertheless encounter difficulties in starting the engine:

▷ Run the starter motor for approx. 20 seconds.

Turn the ignition key back to 1 or 0.

BMW 520d, 525d, 530d:

When the engine is cold, a fuel-burning auxiliary heater is used to warm the car's interior more rapidly. Its exhaust fumes are discharged under the door sill on the driver's side.

If the engine is stopped before it has reached its regular operating temperature, the auxiliary heater continues to run for a short time, and therefore produces exhaust fumes.

 Never remove the ignition key while the car is still moving, as otherwise the steering lock will engage. When leaving the car, always remove the ignition key and lock the ignition lock.

Manual-gearbox cars:

When parking on a slope, apply the handbrake, because even engaging first or reverse gear may not reliably prevent the car from rolling away.

Automatic transmission cars:

Select position P. ◀

Handbrake

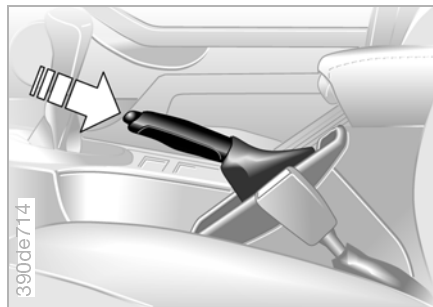

The handbrake is primarily intended for preventing a stationary vehicle from rolling away, and acts on the rear wheels.

Applying

The lever engages automatically and the indicator light on the instrument panel lights up in ignition key position 2, see page 18.

Releasing

Raise slightly, press the knob and move the lever down.

 In exceptional cases, if the handbrake has to be used to slow or stop the car, do not pull the lever up too hard. Keep the knob on the lever held in all the time.

Too violent an application of the handbrake could over-brake the rear wheels and cause the rear of the car to skid. The brake lights do not come on when the handbrake is applied.

Manual-gearbox cars:

When parking on a slope, apply the handbrake, because even engaging first or reverse gear may not reliably prevent the car from rolling away.

Automatic transmission cars:

Select position P. ◀

To prevent corrosion or an imbalance between the brakes on the right and left side, apply the handbrake lightly from time to time when coasting to a standstill, for instance at traffic lights, provided that it is safe to do so.

Manual gearbox

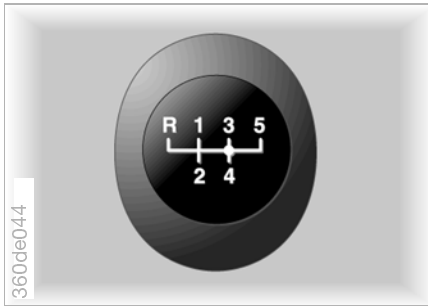

Reverse

Engage only when the car is standing still. When the gear lever is pressed to the left, a slight resistance has to be overcome.

The reversing lights then come on automatically in ignition key position 2.

 Never try to prevent the car from rolling back on an uphill gradient by slipping the clutch; always apply the handbrake. A clutch that is allowed to slip will wear rapidly. ◀

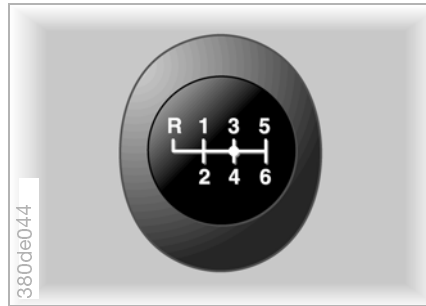

BMW 540i

 When selecting a gear in the 5th/6th gear plane, always press the lever to the right, to avoid accidentally selecting a gear in the 3rd/4th plane of the gate. ◀

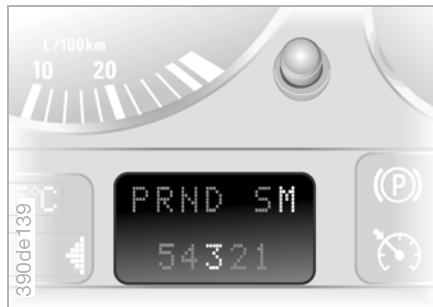
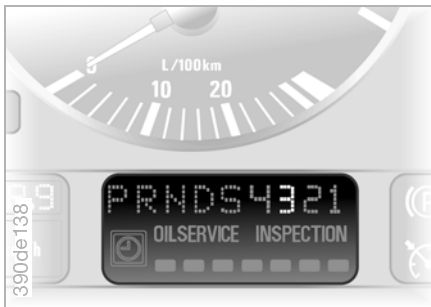

You can either drive the car as with a conventional automatic transmission, or shift between gears yourself.

If you move the selector lever from position D to the left, into the M/S lever plane, this will activate automatic-transmission shift programs that will appeal to those who wish to adopt a more enthusiastic driving style. As soon as you move the lever in the "+" or "-" direction, the Steptronic transmission's manual gear shift mode is activated. If you wish to return to fully automatic gear shifts, move the lever back to the right, to position D.

Selector lever positions

P R N D M/S + -

Starting the engine

The engine can only be started in positions P or N.

The gear display differs according to your car's equipment specification (see pictures).

Moving the selector lever

An interlock prevents selector lever positions R and P from being engaged inadvertently. To override the interlock, press the button on the front side of the selector lever knob (arrow).



Before moving the selector lever away from P or N with the car at a standstill, you must press the brake pedal down to release the lever (shift-lock).

Keep the brake pedal pressed down until ready to move away, so that the car does not creep forwards (or backwards as the case may be) with the gear engaged. ◀

! Before leaving the car with the engine running, move the automatic transmission selector lever to position P or N and apply the hand-brake to prevent the car from moving. Do not leave the car unattended with the engine running, as this constitutes a potentially severe accident risk. ◀

P Park

Engage only when the car is standing still. The driven wheels are locked.

R Reverse

Engage only when the car is standing still.

N Neutral

Select only if the journey is interrupted for a fairly long time.

D Drive (automatic shift position)

Use this position for all normal driving. All forward gears are available.

"Kick-down"

In "kick-down" position, you achieve maximum acceleration and top speed in position D.

Press the accelerator pedal down beyond the regular full-throttle position; increased resistance will be felt.

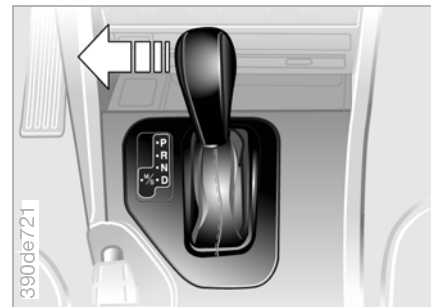

M/S Manual mode and Sport program

When changing from D to M/S, the Sport program is activated and D S displayed on the instrument panel. This position is recommended if it is intended to make full use of the car's available performance.

When the lever is next moved, the automatic transmission will switch from the Sport program to the manual-shift mode. If you press the lever briefly in the "+" direction, the transmission shifts up; if you press it in the "-" direction, a downshift takes place. The gear display reads 1 to 5 or M1 to M5 according to version.

ATC performs up- and down-shifts only at a suitable engine or road speed; for example, it will not shift down if the resulting engine speed would be too high. The instrument panel shows the selected gear briefly, followed by the gear actually in use.

 For rapid acceleration in the manual-shift mode – for example when overtaking – shift down manually or use the kick-down to shift to a lower gear. ◀

The selector lever can only be moved from M/S to the positions P, R and N if it has first been moved back to D.

Shift electronics



If the warning light comes on or the message "TRANS. FAIL-SAFE PROG" appears in the Check Control, an automatic transmission malfunction has occurred.

All lever positions can still be selected, but in the forward positions only certain gears are actually available when the car is driven.

Avoid excessive loads, and take the car to the nearest BMW Service.



Do not work in the engine compartment with the selector lever in a driving position, in case the car begins to move unexpectedly. ◀

Towing, tow-starting and jump-starting: see pages 173, 175.

Turn indicator/flasher

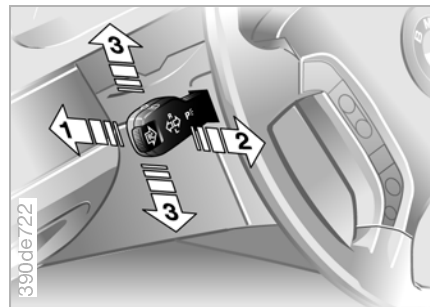

- 1 High beam headlights (blue indicator light)
- 2 Headlight flasher (blue indicator light)
- 3 Flashing turn indicators (green repeater lights with rhythmic ticking of flasher relay)

To indicate a turn briefly

Move the lever lightly, only as far as the first detent. It will cancel when released.



If the indicator light of the turn indicator repeater flashes and the relay ticks more rapidly than usual, a flashing turn indicator has failed; if towing a trailer, the failed light could be on the trailer. ◀

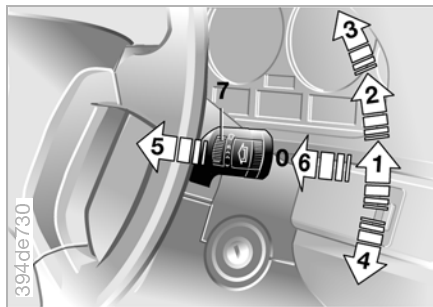

- 0 Parked position of wipers
- 1 Intermittent operation or rain sensor*
- 2 Normal wiper speed
- 3 Fast wiper speed
- 4 Flick wipe
- 5 Windscreen washer
- 6 Intensive cleaning*
- 7 Knurled wheel for controlling the intermittent wipe intervals and the sensitivity of the rain sensor

Intermittent operation or rain sensor*

Intermittent operation:

Using knurled wheel 7 you can select four intermittent wipe intervals. The wipe speed is also varied automatically, according to road speed.

Rain sensor:

The rain sensor is mounted on the windscreen, directly ahead of the inside mirror.

Activating the rain sensor:

From ignition key position 1, move the lever to setting 1. In any event, the wipers will now cross the windscreen once.

You can leave the lever in setting 1 all the time, then all you need to do is to activate the rain sensor from ignition key position 1.

Turn knurled wheel 7 briefly.

To vary the sensitivity of the rain sensor:

Turn knurled wheel 7.

Deactivating the rain sensor:

Move lever to position 0.



Deactivate the rain sensor in an automatic car wash, otherwise the car's wipers may operate and be damaged. ◀

Normal wiper speed

The wipers change over automatically to the intermittent wipe mode when the car comes to a standstill (not on cars with rain sensor).

Fast wiper speed

The wipers switch to normal speed when the car comes to a standstill (not on cars with rain sensor).

Windscreen washer

Fluid from the washer tank is sprayed on to the windscreen and the wipers are operated for a short time.

Intensive cleaning*

Same as 5, but intensive cleaning fluid is first sprayed on to the windscreen.

Changing the wiper blades: see page 160.

Headlight cleaning*

If the headlights are switched on, they are automatically cleaned as well on each fifth occasion that the windscreen washer 5 or the intensive cleaning system 6 is operated.

 The driver should only operate the washers and cleaning equipment if certain that the fluid will not freeze to the windscreen and interfere with the view ahead. Antifreeze should therefore be added to the fluid; see page 150. Do not run the washer systems if the fluid reservoirs are empty, or the washer pump will be damaged. ◀

Windscreen washer jets

The windscreen washer jets are automatically heated when the ignition key is in position 2.

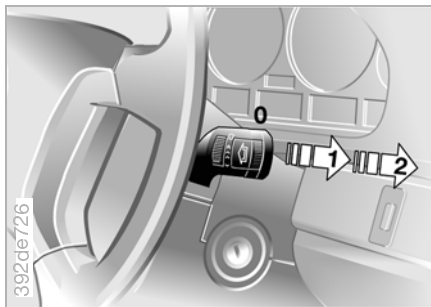
**Rear window wiper – touring**

0 Parked position of rear window wiper

1 The rear window wiper operates intermittently. When reverse gear is engaged, the wiper operates continuously

2 Rear window washer

You can program the desired wipe interval:

- ▷ Move the lever briefly from position 0 to position 1 and back
- ▷ The time which elapses before switching on again (from 0 to 1) is the programmed wipe interval (max. 30 seconds).

Programming is cancelled:

- ▷ By moving the lever to position 0 for approx. 10 seconds, or
- ▷ When the engine is switched off.

When the rear window is opened, its wiper is switched off. After closing the window it then has to be restarted if required.

To renew the wiper blade, see page 160.

Cruise control*

Above about 30 km/h (approx. 20 mph), you can memorise and call up the car's road speed.

You can use the cruise control if the system is activated with the engine running.

Activating the system

I/O

From ignition key position 2: Press the button; the indicator light in the instrument panel (see page 19) comes on. You can then use the cruise control.



Do not use the cruise control on twisting roads, in heavy traffic which prevents a constant speed from being maintained or if the road surface is slippery (snow, rain, ice) or loose (stones, sand). ◀

Deactivating the system

I/O

Press the button as often as necessary until the indicator light in the instrument panel goes out.

The cruise control is also deactivated when the ignition key is turned to position 0.

The memorised speed is deleted.

Maintaining and memorising speed, accelerating



Press button (+) briefly:

The car's actual speed is maintained and memorised. Each time the button is pressed briefly again, road speed is increased by approx. 1 km/h.

Hold button (+) pressed

The car accelerates without the accelerator pedal being touched. As soon as you release the switch, the speed the car has reached will be maintained and memorised.



If engine braking alone is insufficient on a downhill gradient, the controlled speed may be exceeded. It may also prove impossible to maintain with the available engine power on uphill gradients. ◀

Decelerating

Press button (-) briefly:

Every time you press the button, road speed drops by approx. 1 km/h if the cruise control is already in use.

Hold button (-) pressed:

The car slows down by automatically closing the throttle if the cruise control is already in use. As soon as you release the switch, the speed the car has reached will be maintained and memorised.

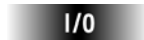
Cancelling the cruise control

When activated, press button: the indicator light remains lit. You can re-activate cruise control as required, by calling up the speed last memorised.

In addition, you interrupt the cruise control function automatically:

- ▷ When braking
- ▷ When operating the clutch or when moving the automatic transmission selector lever from D to N
- ▷ If the selected speed is exceeded or not reached for a lengthy period, for instance by depressing the accelerator pedal.

Calling up memorised speed

Press the button:

The speed last memorised is recalled and maintained once it has been reached again.

Trip distance recorder/outside temperature display

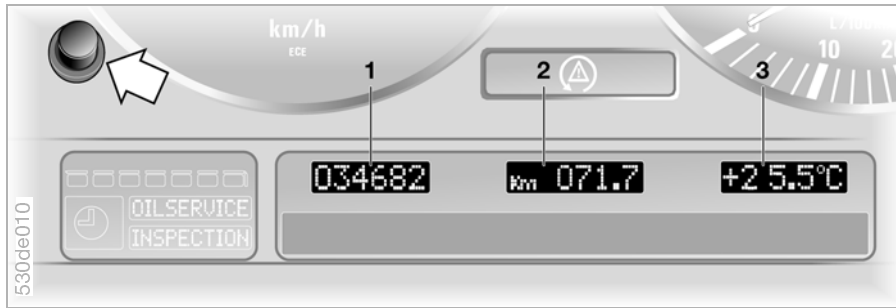

- 1 Odometer (distance recorder)
- 2 Trip distance recorder
- 3 Outside temperature display

Odometer (distance recorder)

You can activate the displays shown in this illustration in ignition key position 0 by pressing the button (arrow) on the instrument panel.

The layout of the displays differs according to your car's equipment.

Trip distance recorder

To reset to zero, press the knob (arrow) in ignition key position 1 or beyond.

Outside temperature display

The outside temperature is displayed from ignition key position 1 on.

You can change the unit of measurement (°C/°F) by

1. Pressing the button (arrow) in ignition key position 1 and holding it down,
2. Then turning the ignition key to 0.

See also page 84.

Ice warning

If the outside temperature drops to approx. +3 °C, a warning signal is heard and the display flashes for a short time.

 Please note that despite the ice warning, ice may occur on the roads at temperatures above +3 °C, for example on bridges or in shade. ◀



Never allow the engine to run in the red zone of the revolution counter.

In this zone the fuel supply is interrupted to protect the engine.

Energy Control



Shows momentary fuel consumption. This enables you to check how economical and environmentally friendly your current driving style is.

When the car is halted, the needle moves back to zero.

Fuel gauge



The warning light comes on briefly as an operating check when the ignition is switched on.

When the warning light comes on, there are approx.

▷ 8 l (1.8 gal) – BMW 520i, 523i, 525i, 530i, 520d, 525d, 530d

▷ 10 l (2.2 gal) – BMW 535i, 540i of fuel left in the tank.

Fuel tank capacity: see page 191.

Fuel gauge

If the car is at an angle for some time, for example on a long mountain road, the display may vary slightly.

 Add fuel in good time, to avoid the risk of running the tank dry and causing damage to the engine or the catalytic converter. ◀

Coolant thermometer



Blue

The engine is still cold. Drive at moderate engine and road speeds.

Red

The warning light* comes on briefly as an operating check when the ignition is switched on.

If the warning light comes on while the car is being driven or if the message "COOLANT TEMPERATURE" appears in the Check Control*: the engine is too hot. Switch it off at once and allow to cool down.

Between the coloured zones

Normal operating temperature. The needle may move up as far as the start of the red zone.

Checking coolant level: see page 152.

80 Service Interval indicator

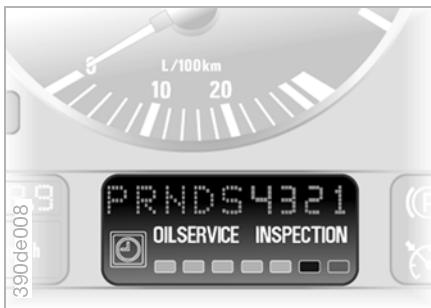

The display layout varies according to your car's equipment specification.

Green light-emitting diodes

The fewer are on, the sooner the next service will be due.

Yellow LED

This lights up in conjunction with OILSERVICE or INSPECTION.

A service routine is due. Make arrangements with BMW Service.

Red LED

The service routine is overdue.

Clock symbol

Shows that brake fluid renewal is due.



Periods during which the battery was disconnected are ignored by the display.

Make sure that brake fluid is renewed every two years, regardless of whether this is confirmed by the display. See also page 154. ◀

Check Control

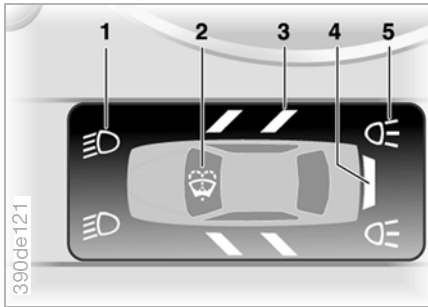

Graphic display

The following instructions and status messages are depicted as symbols and sound a gong from ignition setting 2. They remain on display until the faults have been remedied:

- 1 Check low- and high-beam headlights and parking lights
- 2 Top up washer fluid – goes out after approx. 1 minute
- 3 Door open
- 4 Luggage compartment lid/tailgate open
- 5 Check rear light or brake light. A defective third (centre) brake light is indicated by the upper symbol

At the end of a journey, when the driver's door is opened, the LIGHTS ON signal may be heard without any visual display.

Alphanumeric display*

Clear-text instructions and reminders are shown in ignition key position 2 and beyond. A gong signal is always heard at the same time.

- 1 Symbol that a warning is present
- 2 Display
- 3 CHECK key

The system malfunction displays are divided into two priority categories:

Priority 1

These displays appear immediately, accompanied by a gong signal and by flashing fault display symbols 1. If several faults occur at the same time, they are displayed in succession. The displays remain in force until the faults have been rectified, and cannot be erased with CHECK button 3:

- ▷ "RELEASE PARKINGBRAKE"
- ▷ "COOLANT TEMPERATURE"
The temperature is too high. Stop the car immediately and switch off the engine; see page 152
- ▷ "STOP! ENGINE OILPRESS"
Engine oil pressure has dropped too low. Stop the car immediately and switch off the engine; see pages 17, 150

▷ "CHECK BRAKE FLUID"

The level is close to the minimum mark. Add fluid at the earliest opportunity; see page 154. Have the cause of brake fluid loss traced and rectified by BMW Service

▷ "TYRE DEFECT"*

Immediately reduce speed and stop, avoid harsh braking and hectic steering wheel motion.

See page 106

▷ "SELFLEVEL SUSP. INACT"*

Have the car checked by the nearest BMW Service; see page 105

▷ "FUEL INJECT.SYSTEM"*

Have the problem examined by BMW Service.

▷ "SPEED LIMIT"*

Displayed whenever you are exceeding the legal speed limit in a given country or the speed limit that you have entered, see page 89.

Priority 2

These faults or reminders are shown for 20 seconds in ignition key position 2 and beyond. After the text displays have gone out, symbols remain visible to indicate that there are fault messages in the Check Control. CHECK button 3 can be used to display the messages again.

▷ "BOOTLID OPEN"

Display only appears when car is driven away from a standstill for the first time

▷ "DOOR OPEN"

Display appears when the car has reached a given (low) speed

▷ "FASTEN SEAT BELTS"*

The indicator light with seat belt symbol also comes on

▷ "PRE-HEATING"*

Do not start the engine until the display has gone out

▷ "WASHER FLUID LOW"

Restore the correct level at the earliest opportunity; see page 150

▷ "CHECK ENGINE OIL LEV"

The oil level has fallen to the absolute minimum level; add engine oil at the next opportunity, see page 150. Do not continue for more than approx. 50 km (approx. 30 miles) without adding oil

▷ "SET TYRE PRESSURE"*

The RDC has accepted the prevailing tyre pressure as the nominal value it has to monitor.

See pages 105

▷ "CHECK TYRE PRESSURE"*

Check the tyre pressure at the next available opportunity (refuelling stop) and correct to the specified levels.

See pages 106

▷ "TYRECONTROL INACTIVE"*

Temporary fault in RDC or system fault, refer to page 106

▷ "CHECK BRAKE LIGHTS"

A bulb has failed or there is a fault in the electrical circuit; see pages 164 and 172 or consult BMW Service

▷ CHECK LOWBEAM LIGHTS

CHECK PARK LIGHTS

CHECK TAIL LIGHTS

CHECK FRONT FOG LAMPS*

CHECK REAR FOG LIGHTS

CHECK NUMPLATE LIGHT

CHECK TRAILER LIGHTS*

CHECK HIGHBEAM LIGHT

CHECK REVERSE LIGHTS

In each case a bulb may have failed or the electrical circuit may have a fault. See page 161 onwards and page 172 or consult BMW Service

Check Control

- ▷ "TRANS FAILSAFE PROG"*
Have the car checked by the nearest BMW Service; see page 72
- ▷ "CHECK BRAKE LININGS"
Have the brake pads checked by BMW Service; see page 144
- ▷ "CHECK COOLANT LEVEL"
Coolant level is too low and should be topped up at the earliest opportunity; see page 152
- ▷ "ENGINE FAILSAFE PROG"*
Fault in the engine electronics. The electronics will allow you to continue your journey at reduced engine output and engine speed.
Please arrange for the problem to be examined by BMW Service.
- ▷ "Outside temperature -5.0 °C"
This is an example of the display. The actual value is shown at an outside temperature of +3 °C or below; see also page 77.

Messages displayed at the end of a journey

All malfunctions which have been indicated during a journey are displayed again in succession when the ignition key is turned back to position 0.

The following information is also provided if appropriate:

- ▷ "LIGHTS ON"
Warning at end of journey, when driver's door is opened
- ▷ "CHECK ENGINE OIL LEV"
Add engine oil at the earliest opportunity (when refuelling); see page 150.

After the ignition key has been removed and the display has gone out, you can call up CHECK CONTROL displays for up to approx. three minutes by pressing the CHECK button. If there are several displays, the CHECK button must be pressed more than once.

Check Control test

Press the CHECK button 3 in ignition key position 2:

The display should show CHECK CONTROL OK.

There are no malfunctions in the systems monitored.

Computer

For a description of the on-board computer, see pages 84 and 89 and the "Operating Instructions for On-Board Computer".



You can also have Check Control messages and computer information displayed in another language. ◀

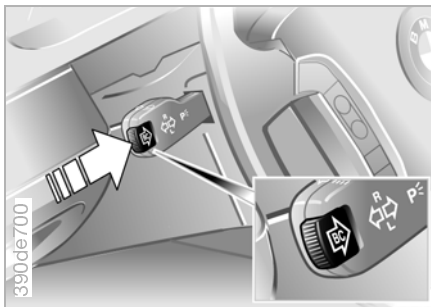

Calling up functions

Using the button in the turn indicator lever, from ignition key position 1, you can call up computer information in the instrument panel display unit. Every time you press the button towards the steering column, another function is displayed on screen (i.e. scrolling function).

The sequence of displays is:
Ambient temperature, average fuel consumption, range, average road speed.

From ignition key position 1, the most recent setting appears on the display.

The layout of the displays differs according to your car's equipment.

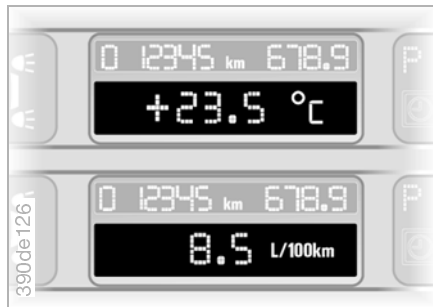

Outside temperature and average fuel consumption

You can vary the unit of measurement (°C/°F) used to display the outside temperature by

1. Pressing and holding down the reset button for the trip distance display (odometer)
2. Then turning the ignition key to 0.

See also page 77.

Operating range and average speed

The range is calculated on the basis of the previous driving style and conditions.

The average speed display ignores any stationary periods where the engine was switched off.

Clearing the display

If you press the button in the turn indicator lever briefly while average speed is displayed, the computer display can be switched off.

Recalculating

If you hold the button down longer, the average values displayed for fuel consumption and road speed are recalculated, starting from this point in time. The engine must be running.

On-board computer with alphanumeric display*

If your car has Check Control with alphanumeric display, the on-board computer that belongs to it is described from page 89 and in the separate "Operating Instructions for On-Board Computer".

Multi-Information Display (MID)*

Central display

The MID is used for the central display and control of the following on-board systems:

- ▷ Digital clock (e.g. time, date)
- ▷ Audio systems (radio, cassette, CD)
- ▷ Computer (e.g. fuel consumption, range before refueling)
- ▷ Telephone (e.g. dialling)

The following pages contain explanations and operating instructions for the digital clock, the computer and the telephone. Operation of the audio systems and the on-board computer is described in the separate operating instruction booklets.

▷ Unrealistic numerical inputs are not accepted. If the power supply is interrupted, all the stored data are erased. After restoring the power supply, the time and possibly also the switch-on times for auxiliary heater/independent ventilation control, distance and speed limit values must be input again. ◀

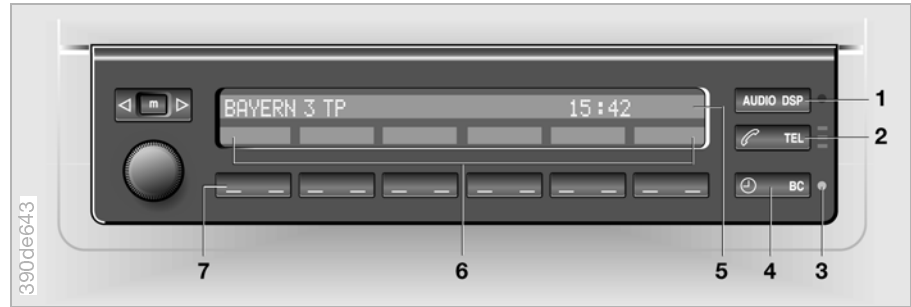

- 1 Function key for audio systems
- 2 Function key for telephone*
- 3 Indicator light for auxiliary heater/independent ventilation control*
 - ▷ Lights up when a switch-on time has been programmed
 - ▷ Flashes during operation
- 4 Function key for digital clock and computer
- 5 Display used by the various on-board systems
- 6 Display for input and call-up keys. Depending on the operating mode, the relevant functions and alternative choices are displayed above the keys
- 7 Input and call-up keys for operation of the various on-board systems

 Only make inputs when the car is standing still – to avoid endangering yourself or other road users. ◀

To call up time or date



Press the left of the key.

Display shows:



You can have the time shown as a 12- or 24-hour clock display, and the date in Imperial order.

To change the display:



Press the left of the key.

If the 12-hour clock display is in use, AM or PM appears after the time.

Altering the time display



Press the left of the key.



Press the right of the key:
The dots flash in the display.

To alter the setting:



Press at left or right, or hold the key down.

To store the input:



Press the right of the key.

Altering the date display



Press the left of the key.



Press.



Press the right of the key:
Dots and the word DATE flash on the display.

To alter the setting:



Press at left or right, or hold the key down.

To store the input:



Press the right of the key.

The clock takes leap years into account and therefore does not have to be reset manually.

Digital clock in MID*

Reminder signal

You can program a reminder signal (Memo) to be heard every hour, so that you are sure not to miss a news broadcast.



Press the left of the key.



Press:

MEMO OFF appears in the display for input and call-up keys and the sound-wave symbol appears at the top right of the display.

A signal is then heard 15 seconds before each hour.

Stopwatch

 The stopwatch functions are only available on cars without an auxiliary fuel-burning heater. ◀



Press the left of the key.



Press.

Display shows:



To start the stopwatch function:



Press the right of the key.

To take an intermediate time reading:



Press.



Press:

The stopwatch display can be seen counting up; the stopwatch continues to run.

To halt the stopwatch:



Press the right of the key.

 The stopwatch is halted when the ignition switch is turned back to 0, but starts to run again when the ignition key is turned to 1. ◀

Entering switch-on times for auxiliary heater/independent ventilation control*

You can enter two different switch-on times.

After 30 minutes, the heating and ventilation shut down automatically.

 Please note the instructions starting on page 120 on use of the auxiliary heater/independent ventilation control. ◀



Press the left of the key.



Press at left/right.

Display shows:



Press the right of the key:
Display flashes, e.g. TIME 1.

To input the time:



Press at left or right, or hold the key down.

To confirm the input:



Press the right of the key.

The activated time is marked with an asterisk.



The switch-on times remain stored until cancelled by a new input.

You can change switch-on times that have already been memorised by making a new time input as described above.

When the switch-on time is active, the LED comes on in the MID. During actual operation of the heating/ventilation, the LED flashes. The LED goes out when the system is switched off.

To activate/deactivate the time:



Press twice.

Direct switching on/off of the auxiliary heater/independent ventilation control*

 The independent heating/ventilation function can only be called up in ignition key position 1. ◀



Press the left of the key.



Press.

or



Press.

Computer in MID*

Selecting units of measurement

 Only make inputs when the car is standing still – to avoid endangering yourself or other road users. ◀

The computer calculates and memorises data from the start of the journey onwards.

Information can also be called up in the display by remote control; see page 93.

Information can be displayed either in metric or in Imperial units of measurement.



Press the right of the key.



Press the left of the key; changeover takes place each time the key is pressed.

Speed limit

Speed limit input:

You can input the road speed at which you wish to hear and see a reminder signal: a signal is heard, the LIMIT inscription flashes and, with the Check Control with alphanumeric display*, the memorised speed limit appears briefly in the instrument panel.

The speed limit reminder is only repeated if the car has in the meantime been driven at least 5 km/h (approx. 3 mph) slower.



Press the right of the key.



Press.



Press the right of the key.

Display shows:



Input the limit by pressing the function keys.

To correct an input:



Press the left of the key and repeat the input.

To store the input:



Press the right of the key.

Memorising actual speed as limit value:



Press the right of the key.



Press.



Press the right of the key twice.

Deactivating the speed limit:



Press the right of the key.



Press.

The LIMIT display goes out, but the memorised value is not lost and can be re-activated by pressing the LIMIT key.

Distance from destination

The distance still to be covered before you reach your destination is displayed. This is of course only possible if you entered the entire distance before starting the journey.

To make the input:



Press the right of the key.



Press the left of the key.



Press the right of the key.

Display shows:



You can input the distance by pressing the function keys.

To correct an input:



Press the left of the key and repeat the input.

To store the input:



Press the right of the key.

Checking memorised value:



Press the right of the key.



Press the left of the key.

Computer in MID*

Estimated time of arrival

When you have input the distance from your destination, you can obtain an estimated time of arrival display which is continuously updated by the computer according to your progress.



Press the right of the key.



Press the right of the key:

The estimated time of arrival is displayed.

Range

The distance which the car should cover on the remaining fuel in the tank is displayed.



Press the right of the key.



Press:

The display shows the probable range.

 If the range falls below 50 km (approx. 30 miles), add fuel to the tank to avoid the risk of damage to the engine or the catalytic converter. ◀

The computer only registers added fuel if the quantity exceeds six litres (1.3 Imp. gal).

Fuel consumption

You can have the average fuel consumption displayed for two different distances, for example a complete journey and part of the journey.

To start the calculation, select the function with the engine running.



Press the right of the key.



Press the left or right of the key:

The display will show the average fuel consumption.

To restart the fuel consumption calculation:



Press the left or right of the key.



Press the right of the key.

Speed

You can obtain a display of the car's average speed.

To start the calculation, select the function with the engine running.



Press the right of the key.



Press:

The display shows the average speed.

To recalculate the speed:



Press the right of the key.

Extended immobiliser function

You can enter a code which has to be input on future occasions before the engine can be started.

If the code is not available or has been forgotten, emergency deactivation is possible; see next page.

Selecting and activating code:



Press the right of the key.



Press the left of the key.

Display shows:



Enter the code at the function keys.

To correct an input:



Press the left of the key and repeat the input.

To store the input:



Press the right of the key.

Turn the ignition key back to 0.

Deactivating the code:

When you are asked to input the code (ignition key in position 1 or 2):

▷ Input the code at the function keys.



Press the right of the key.

After the code has been input correctly and confirmed with the SET key, the time display appears.

Computer in MID*

After three incorrect code inputs, or three attempts to start the engine without a code input, the alarm will sound for 30 seconds on cars fitted with an alarm.

Emergency deactivation:

If you have forgotten the code, proceed as follows:

1. Disconnect the battery (the alarm will sound on cars with an alarm system), wait approx. 2 minutes and then reconnect it
2. Turn the ignition key to position 1. The time display will count down for the next ten minutes
3. After ten minutes, start the engine.

▷ If the code becomes available again in the meantime, it can be input during the waiting period after pressing the CODE key. ◀

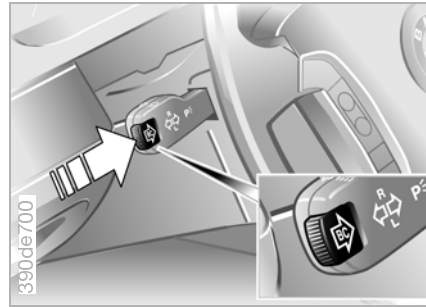

Remote control

The button in the flashing turn indicator lever can be used to select the items of computer information which are to be displayed.

To do this, press:

- ▷ The button on the indicator lever until the display shows PROG 1
- ▷ The MID keys in the order in which you wish the information to be displayed.

Each time an entry is stored, the program number appears on the display.

To terminate the selection procedure:



Press the right of the key.

To have all the available information displayed, press

- ▷ The button on the indicator lever until the display shows PROG 1
- ▷ The SET key.

To obtain individual items of information, press the button in briefly as often as necessary.

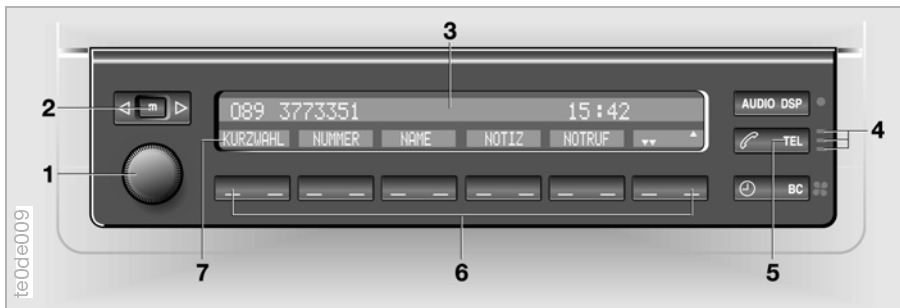

Telephone operation using MID

Using the MID, you can carry out the following telephone functions quickly and directly:

- ▷ Emergency call
- ▷ Dialling by name
- ▷ One-touch dialling
- ▷ Dialling by entering phone number
- ▷ Notepad function.

You can also call up information on the reception level, duration of call and call charges, and read SMS messages.

These functions will operate provided you have stored the relevant items in the telephone (services menu, call meter) using the handset or have activated the necessary functions.

The telephone can be operated using the MID from ignition key position 1.

Displays and operating elements

- 1 Rotary control for on/off, setting the volume in audio mode and the telephone hands-free mode
- 2 Search key
- 3 Display used by the various on-board systems
- 4 Indicator light for telephone operation
 - ▷ Red, the telephone cannot be used
 - ▷ Green, connection has been made
 - Flashing: only emergency calls can be made
 - ▷ Yellow, telephone is logged onto a different network

5 Function key for telephone operation

6 Function keys for the menu bar

7 Display for entry and query keys

Telephone operation via MID*

Activating telephone operation



Press the right of the key.

According to the symbols in the display, either insert the card into the handset or enter the code.

Emergency call

It is also possible to make an emergency call in the GSM network without having entered the SIM card or code.



Press the right of the key.

As an example, the following appears in the display:



Ignore everything in the display and press:



and then



Press the left of the key.

To end an emergency call:



Press the left of the key.

Entering your PIN code

The system asks you to enter your PIN code when it is switched on (PIN = Personal Identification Number).



The display asks for the PIN code.

▷ Enter the digits of your PIN code one after the other.



Press the left of the key if you need to correct an entry.



Press the right of the key to confirm the entry.

Dialling by name

Press the right of the key.

As an example, the following appears in the display:



It is necessary to have memorised the relevant names with their numbers on the SIM card.

To call up names:



As an example, the following appears in the display:



To call the subscriber JULIA, for example, press:



and then



Press the left of the key.

To call up further names:



Press at left/right.

Further names are shown in alphabetical order.

Dialling via the TOP-8 function

Using this function, you can call up the eight names or phone numbers that you dial most frequently. You can only use this function if you have memorised these names or phone numbers on your SIM card and if you have already called the subscribers in question.



Press the right of the key.

As an example, the following appears in the display:



The names appear in alphabetical order. In order to call up further names (max. 4):



Press at left/right.

To call up further functions:



Press at left/right.

If a name has not been used very often recently, it is automatically removed from the TOP-8 list and has to be dialled using the "Dialling by name" function.

One-touch dialling



Press the right of the key.

If you have already made phone calls using the names or phone numbers from the SIM card, the following appears in the display, for example:



Press the right of the key.

The following appears in the display:



It is necessary to have memorised the corresponding names and phone numbers on the SIM card. The one-touch dialling number is identical to the memory location.

To enter a one-touch dialling number:



Press.

The following appears in the display:



Enter the appropriate one-touch dialling number with the 0 – 9 keys.

To correct your entry:



Press the left or right of the key and continue counting or overwrite the digits.

To call up a specific one-touch dialling number using the search key:



Press at left/right.

If no name is found under the one-touch dialling number that you have called up, the following appears in the display:



Dialling by phone number



Press the right of the key.

The following appears in the display:



Press.

The following appears in the display:



Enter the appropriate phone number with the 0 – 9 keys.

To correct your entry:



Press the left of the key briefly, the digits are deleted one at a time.



Keep the left of the key pressed down: the entire number is deleted.

To call up a certain phone number using the search key:



Press at left/right.

You can use the search key to display the ten numbers last dialled, and then dial one of them.

Notepad function

You can also enter a new number in the notepad memory during a phone call and in this way store it on the SIM card.



Press the right of the key.

The following appears in the display:



Press.

The following appears in the display:



Enter the appropriate phone number with the 0 – 9 keys.

To correct your entry:



Press the left of the key briefly, the digits are deleted one at a time.

CLR SET



Keep the left of the key pressed down, the entire number is deleted.

Memorising phone numbers:

SET



Press the right of the key.

Call up the number directly from the memory:

NOTE PAD



Press and then, to dial

TEL

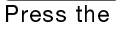

Press the left of the key.

Additional functions

You can call up the following information from all telephone functions:

- ▷ Reception signal
- ▷ Call charges and
- ▷ Call duration (assuming that charges have been selected)
- ▷ Reading SMS messages.



Press the right of the key.

The following appears in the display:



Press the left of the key.

The following appears in the display:



The reception signal is always displayed first after a number has been dialled.

To call up the charge display:

METER



The individual charge for the current call and the total charge are displayed.

To call up duration of call:

TIMER



The duration of the current call is displayed. By pressing the SIGNAL key, the reception signal is shown again.

To return to the initial function:



Press the right of the key.

100 Telephone operation via MID*

Reading SMS messages

A screen showing the word "SMS" in a dark box.A screen showing two underscores in a dark box.

Press.

The menu line shows memorised messages. The * symbol indicates messages that have not yet been read.

A screen showing a list of messages. The first line is "3:42PM". The second line shows "1", "2", "*3", "4*", and a right arrow.

If more than 10 messages are memorised:

A screen showing a key with a left arrow, a box with "m", and a right arrow.

Press the right of the key; the next memorised messages will be shown; Press the left of the key to return to earlier messages.

A screen showing "1" and "2" in a dark box.A screen showing two underscores in a dark box.

Press to display the memorised message.

A screen showing a key with a left arrow, a box with "m", and a right arrow.

Press the right of the key to display the next line of text; Press the left of the key to display the previous line of text.

A screen showing "CLR" and an up arrow in a dark box.A screen showing two underscores in a dark box.

Press the right of the key to display the message overview.

Calling the sender back

With message displayed:

A key with a telephone handset icon and the text "TEL".

Press the left of the key to dial the sender.

Erasing message

A key with "CLR" and an up arrow.A key with two underscores.

Press and hold in the left of the key for more than 3 seconds; the message being displayed will be erased.

Park Distance Control (PDC)*

The principle

PDC assists you when manoeuvring into a parking space. Audible warning signals indicate when the car is approaching an obstacle. Four ultrasonic sensors in the front and four in the rear bumper measure the distance from the nearest object. The range of the sensors at the front of the car and at the two rear corners ends approx. 60 cm (approx. 2 ft) away from the bumper. The centre sensors at the rear have a range of approx. 1.50 m (approx. 5 ft).

If the car is towing a trailer, the rear sensors clearly cannot supply sensible signals and therefore remain switched off.

Automatic function

In ignition key position 2, the system is activated automatically after approx. 1 second when reverse gear is selected or the automatic transmission selector lever moved to R.



Switching on manually

Press the button, the indicator light comes on.

After a distance of approx. 50 m (approx. 164 ft) has been covered or a speed of approx. 30 km/h (approx. 20 mph) is exceeded, the system is deactivated and the indicator light goes out. Switch the system on again as necessary.

Switching off manually

Press the button again.

Audible warning signals

The distance from an obstruction is indicated by a higher intermittent audible signal for the front end, and a lower-pitched intermittent audible signal for the rear end. The closer the car approaches the obstruction, the more rapid the sequence of signals. When the distance is less than 30 cm (approx. 12 in), the signal becomes continuous.

The signal is interrupted after approx. 3 seconds if you are driving parallel to a wall.

The system has developed a malfunction if:

The indicator light flashes and a continuous tone is emitted briefly

- ▷ When you switch on PDC at the button
- ▷ When you engage reverse or selector lever position R for the first time after switching on the ignition
- ▷ If the malfunction occurs while PDC is active.

Switch off the system and have the cause of the malfunction rectified by BMW Service.

Park Distance Control (PDC)*



PDC is no substitute for your personal assessment of obstructions. The sensors have certain "dead areas" in which objects cannot always be detected. In addition, the identification of objects may not be possible if the physical limits of the ultrasonic measuring principle are exceeded, for instance in the case of trailer tow hitches and towbars, and also other thin or wedge-shaped objects. Loud sound sources such as loud radios can overpower the PDC signal tone. ◀



Keep the sensors clean and free from ice, so that they always operate reliably. Do not spray the sensors for any length of time with a high-pressure cleaning jet. Keep such jets at least 10 cm (approx. 4 in) away from the sensors. ◀

ASC+T/DSC*

Automatic Stability Control plus Traction (ASC+T)/Dynamic Stability Control (DSC)*

These systems ensure additional dynamic stability, particularly when accelerating and cornering.

The DSC adds to the advantages of ASC+T. In addition to achieving optimum dynamic stability when accelerating and starting from a standstill, a gain in stability is obtained when cornering. Note however that the car always remains subject to the limits imposed by the basic laws of dynamics.

The system is in operation whenever the engine has been started.

Indicator light



The indicator light on the instrument panel goes out shortly after the engine has been started. See page 18.

If the indicator light flashes:

The system is active, and regulates tractive and braking forces.

If the indicator light does not go out after starting the engine, or remains on during a journey:

The system is either defective or has been switched off at the button provided. The car can be driven normally without ASC+T/DSC. Please visit BMW Service for repair work.



Switching off

Press the button, the indicator light remains on all the time.

Depending on the car's equipment, the button is marked either ASC or DSC.

In the following exceptional situations it may be best to switch off ASC+T/DSC for a short time:

- ▷ If the car has to be rocked out of a hollow or a soft surface, or started in deep snow or on a loose surface
- ▷ If snow chains are fitted.

Switching on again

Press the button again; the indicator light will go out.



Not even ASC+T/DSC can overcome the laws of physics. It is therefore the driver's responsibility to adopt a suitable driving style in every situation. Avoid taking any risks on account of the additional safety afforded by this system. ◀

Dynamic Brake Control (DBC)*

DBC is part of DSC.

If the brake pedal is pressed down rapidly, this system automatically boosts the braking force to a maximum and thus helps to pull the car up in the shortest possible distance when a full brake application is made. It also makes full use of the advantages offered by ABS.

Maintain pressure on the brake pedal during the entire brake application. If the brake pedal is released, DBC will be switched off.

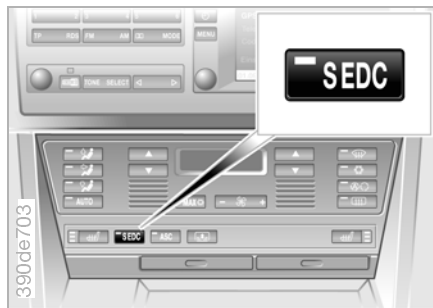
Electronic Damping Control (EDC)***Sport program**

In ignition key position 2, press the button; the indicator light will come on. The Sport program should be selected if you require a firmer response from the suspension in all operating situations.

To change over to automatic control: Press the button again; the indicator light will go out.

This system automatically ensures that movement of the road wheels is damped according to the car's needs, and therefore enhances both ride comfort and safety.

Automatic control

Automatic control is activated each time the engine is started. It takes effect over the entire road-speed range and regardless of the load on the car. If the influencing factors change (road surface quality or operating conditions such as steering, braking etc.), the damping action is modified automatically in a fraction of a second to suit the new situation.



The self-levelling suspension warning light comes on and the Check Control displays the "SELFLEVEL SUSP.INACT": the self-levelling suspension is malfunctioning.

Stop the car and examine it. If the body is distinctly lower at the back than at the front, and possibly standing at an angle (for instance, lower at the left than at the right), take it to the nearest BMW Service. Drive cautiously while the car is in this condition. The car's ground clearance is reduced and its ride comfort below the usual standard.

Even if the car appears to be at its normal ride height and attitude, always take it to BMW Service if a malfunction is displayed.

The principle

RDC monitors the air pressure in all four tyres, including when the car is being driven. The system reports any sudden loss of pressure in one or more tyres.

So that the system can identify the correct tyre pressures, first check these against the tyre pressure tables starting on page 25 and correct them if necessary. Then activate the system.



This indicator light on the instrument panel or the Check Control informs you whenever tyre pressure is not normal.

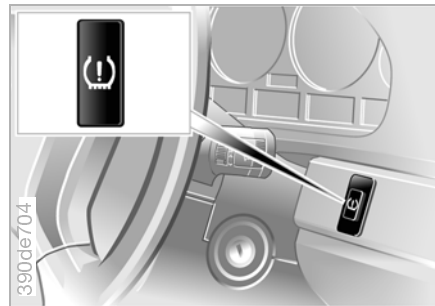

Activating the system

1. Turn the ignition key to position 2 (do not start the engine)
2. Keep the button pressed in until the yellow indicator light on the instrument panel comes on for a few seconds or the Check Control displays "SET TYRE PRESSURE"
3. After the car has been driven for a few minutes, RDC adopts the actual tyre pressure as the desired value to be monitored.

You do not need to repeat this procedure unless the tyre pressures have been corrected in the meantime. The system will be activated automatically each time the ignition key is in position 2 and therefore each time the car is driven.

If there is a loss of tyre pressure

If the tyre pressure has dropped too far in the course of time (quite normal on any tyre), the indicator light comes on yellow or the message "CHECK TYRE PRESSURE" appears in the Check Control.

This is to remind you that the tyre pressure should be corrected to the specified values again as soon as possible.

 If you are asked to check tyre pressures shortly after correcting them, the corrected pressure values were not plausible. Please check the tyre pressures again and correct them to the values specified in the tyre pressure table. After this, re-activate the system. ◀

With a burst tyre

If you suffer a tyre defect involving loss of pressure, the red indicator comes on, or the message "TYRE DEFECT" appears in the Check Control. In addition, a gong sounds.

When this occurs, slow down to a stop immediately, avoiding harsh braking and steering manoeuvres. Replace the defective wheel with tyre.

 The spare wheel supplied as standard with your car is equipped with the necessary RDC electronics and is therefore also monitored automatically after fitting, when the system has been activated. ◀

 RDC is unable to warn the driver of sudden, severe tyre damage caused by outside influences. ◀

 Have your tyres changed by BMW Service. BMW Service has the necessary information and special tools for maintenance of the RDC system. ◀

Faults

While there is a fault in the system, the indicator light comes on yellow or the message "TYRECONTROL INACTIVE" appears in the Check Control.

The same display appears

- ▷ In the event of a system fault
- ▷ If a wheel not equipped with RDC is fitted to the car
- ▷ If one or more wheels equipped with RDC electronics are carried on the car in addition to the spare wheel.

Consult your BMW Service if necessary.

Side lights/low-beam (dipped) headlights



Side lights



In this switch position the lights are on all round the car. You can use the side lights for parking.

There is the additional option of switching on the lights on the side facing the road when parked, see page 109.

Low-beam headlights



If you switch off the ignition while the low-beam headlights are switched on, only the parking lights remain lit.



Headlight courtesy delay feature:
If you press the headlight flasher after parking the car, with the lights switched off, the low-beam headlights come on for a short time. You can have this function deactivated if not required. ◀

LIGHTS ON warning

When the ignition key is turned back to 0 and the driver's door is opened, a buzzer sounds for several seconds as a reminder if the lights are still on.

On cars with alphanumeric Check Control*:

The reminder appears on the Check Control; see page 83.

Daytime circuit*

If desired, the light switch can remain in the low-beam headlights position: when the ignition is turned off, the car's lights go out.

Please comply with local legislation concerning the use of daytime driving lights.

The side lights can be switched on in the normal way when required, as described under "Side lights".



You can have the daytime dipped headlight setting selected on your car. ◀

Automatic driving lights control*



In this switch position, the low-beam headlights are switched on or off automatically depending on ambient light conditions (e.g. tunnels, twilight) and in rain or snow.



The outside lights remain switched on if you in addition switch on the fog lights after the lights have come on automatically. ◀



The driving lights control function is no substitute for your individual judgment of when it is necessary to switch on the lights. The sensors are unable to detect fog, for instance. In such situations, switch the lights on manually, to avoid causing a safety risk. ◀



You can have the sensitivity of the driving lights control on your car adjusted. ◀

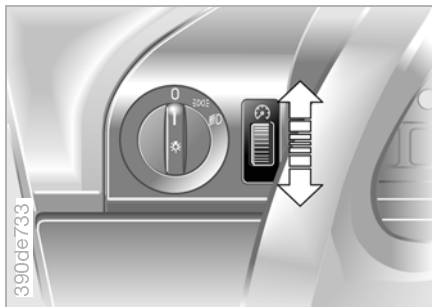

Turn the knurled wheel to vary the intensity of the lighting.

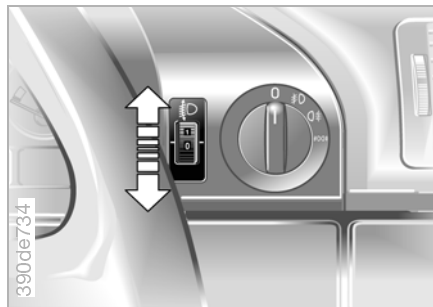

To avoid dazzling oncoming traffic, the angle of the dipped headlight beams must be varied to suit the load being carried in or on the car.

Values in () apply when towing a trailer.

- 0 (1) = 1 to 2 persons without luggage
- 1 (1) = 5 persons without luggage
- 1 (2) = 5 persons with luggage
- 2 (2) = 1 person, luggage compartment or load area full

Cars with self-levelling suspension*:

All load conditions: position 0.

Exception:

1 person, luggage compartment or load area full and when towing a trailer: position 1.

Comply with permitted rear axle load, see page 185.



Please use the correct settings to avoid dazzling oncoming drivers. ◀

Xenon headlights*

Cars with xenon headlights are equipped with automatic beam throw adjustment.

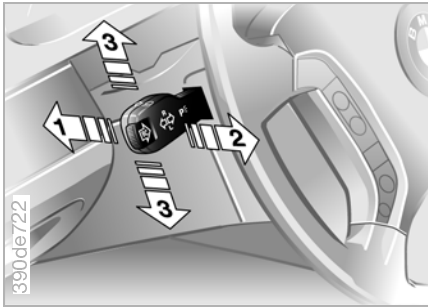

- 1 High-beam headlights (blue indicator light)
- 2 Headlight flasher (blue indicator light)
- 3 Parking light

Right or left parking lights

There is an additional option of switching on the lights on the side of the car facing the road when parked (if permitted in the country of use):

With the ignition key in position 0, move the lever to the appropriate turn indicator position (left/right) and allow it to remain there.

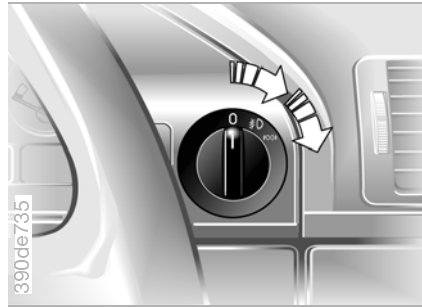

Fog lights*

 The green indicator light on the instrument panel comes on when the fog lights are in use.

Fog lights and rear fog lights

 The green and yellow indicator lights on the instrument panel come on when the front and rear fog lights are switched on.

After switching on the rear fog lights, the switch returns automatically to its initial position.

Please comply with local legislation concerning the use of front and rear fog lights.

 If automatic driving lights control has been activated, the low-beam headlights come on automatically when the fog lights are switched on. After switching on the rear fog lights, the switch returns automatically to its initial position. If the switch is left in this position, the rear fog lights will remain off when the engine is restarted. They can be switched on again if needed. To switch off the rear fog lights, turn the switch to the right again. ◀

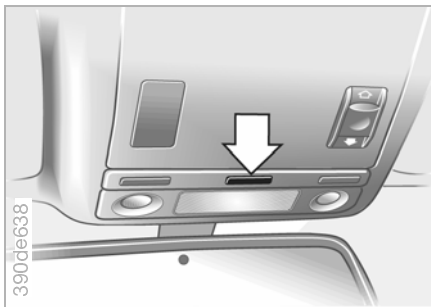

The interior lights are controlled automatically.

Switching interior light on and off manually

Press the button (arrow) briefly.

To switch off the light permanently, hold the button depressed for about 3 seconds.

To cancel this mode, press the button.

The load-area light in the touring operates in the same way.

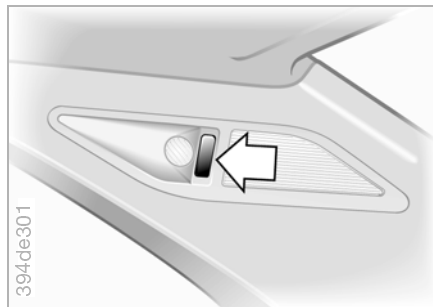

There are reading lights at the front next to the interior light, and in the rear passenger area. They can be switched on and off using the buttons beside them.

 To protect the battery, all lights inside the car are switched off about 15 minutes after the ignition key has been turned to 0. ◀

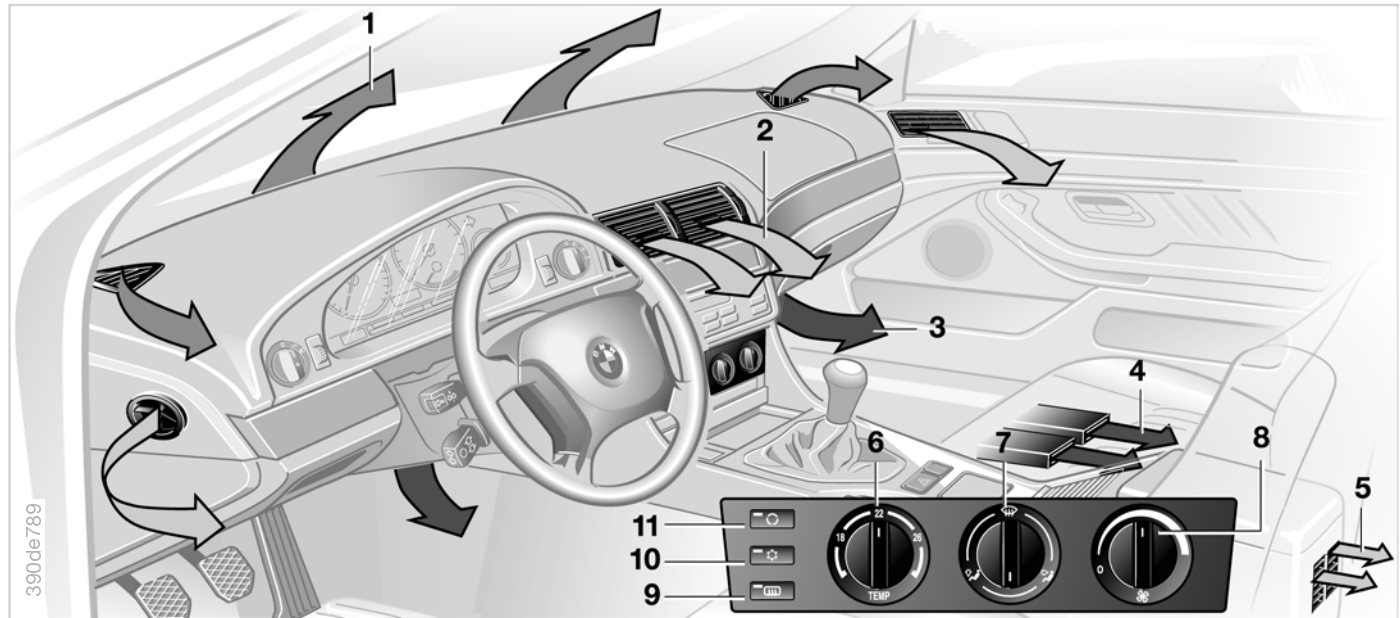

1 Air to windscreen and side windows

2 Air to the upper body 113

3 Air to footwell

4 Air to rear-seat footwell

5 Air to upper-body area, rear-seat passengers 113

6 Temperature 112

7 Air distribution 112

8 Air supply 112

9 Heated rear window 112





10 Cooling 112

11 Recirculated air mode 112

Temperature

The scale values are guide figures for the interior temperature. 22 °C has been found to be a pleasant setting. When the car is in motion, the selected temperature is reached as soon as possible and held constant.

Air distribution

You can direct the air to the windows , onto the upper body  and into the footwells . Any intermediate setting is possible. In position  a small amount of air continues to reach the windows in order to prevent them from fogging over.

Air supply

The airflow volume can be continuously varied. The greater the incoming flow of air, the more effective heating and ventilation will be. In position 0 the blower and air conditioning are switched off and the fresh air supply from outside the car is entirely shut off.

Heated rear window

When the heated rear window is switched on, the indicator light comes on. The heated rear window switches itself off automatically.

Cooling

Air is cooled and dried when the air conditioning is switched on, then re-heated to suit the temperature setting. Depending on weather conditions, the windscreen may fog over momentarily when the engine is started. Switching on the air conditioning system reduces this effect.



Moisture condensate forms in the air conditioning and is discharged underneath the car. Traces of water on the ground are therefore normal. ◀

Recirculated air mode

If there are strong smells outside, you can shut off the supply of outside air for temporary periods. The air inside the car is then recirculated.

If your car has a multifunctional steering wheel with recirculated air button, this can also be used to shut off the incoming airflow (see page 20).



If the windows mist up in recirculating mode, switch this mode off and, if necessary, also increase the air supply. ◀

Auxiliary heater

BMW 520d, 525d, 530d:

When the engine is cold, there is a fuel-burning auxiliary heater for warming up the car's interior more rapidly. Its exhaust fumes are discharged under the door sill on the driver's side. If the engine is stopped before it has reached its regular operating temperature, the auxiliary heater continues to run for a short time, and therefore produces exhaust fumes.

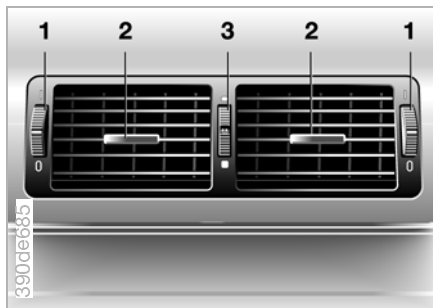

Draught-free ventilation

The outlets for the occupants' upper body area can be adjusted to suit your personal preferences:

- 1 Knurled wheels for opening and closing the air outlets continuously
- 2 Levers for altering the airflow angle
- 3 The knurled wheel allows you to vary the temperature of the airflow:
 - ▷ Turn towards the blue mark – cooler
 - ▷ Turn towards the red mark – warmer.

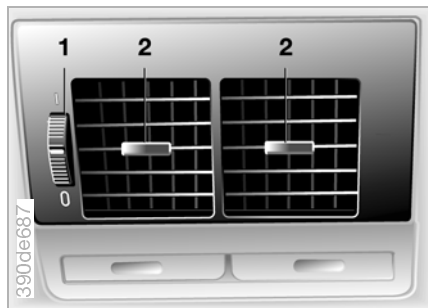

Rear-seat area ventilation

- 1 Knurled wheel for opening and closing the air outlets continuously
 - 2 Levers for altering the airflow angle.
- The air emerging here is slightly cooler than the air for the footwell.

Micro-filter

The micro-filter traps dust and pollen in the incoming airflow. It is renewed when BMW Service carries out routine maintenance work. If the air supply is noticeably less than usual, this may indicate that the filter should be renewed earlier.

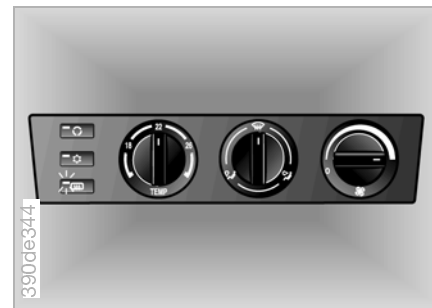

Defrosting and demisting windows

1. Use the rotary temperature selector to preselect your preferred interior temperature, e.g. 22 °C
2. Turn the rotary air distribution control to position 
3. Turn the rotary blower control (air supply) fully to the right
4. Close the rear-seat area outlets
5. To defrost the rear window, switch rear window heating on.

114 Automatic air conditioning

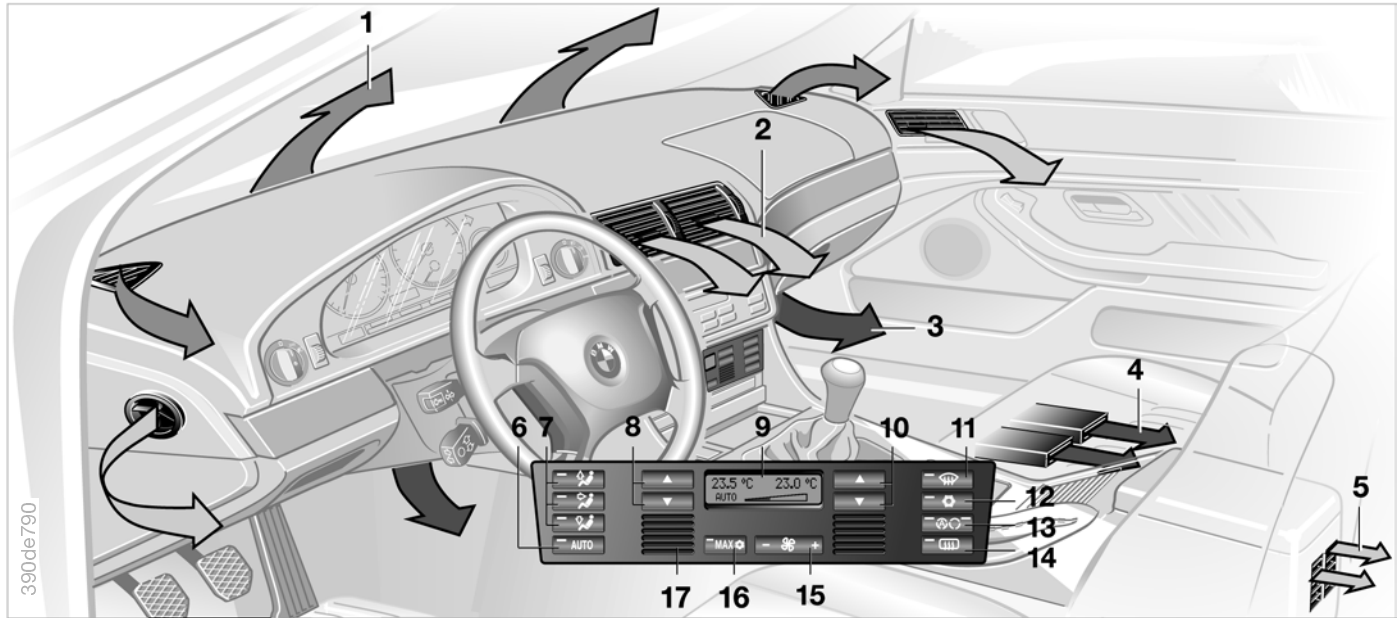

1 Air to windscreen and side windows
2 Air to the upper body area 118
3 Air to footwell

4 Air to rear-seat footwell
5 Air to upper body area, rear-seat
passengers 119
6 Automatic air distribution 116

7 Individual air distribution 116
8 Temperature - left side 116
9 Temperature display, air supply 116

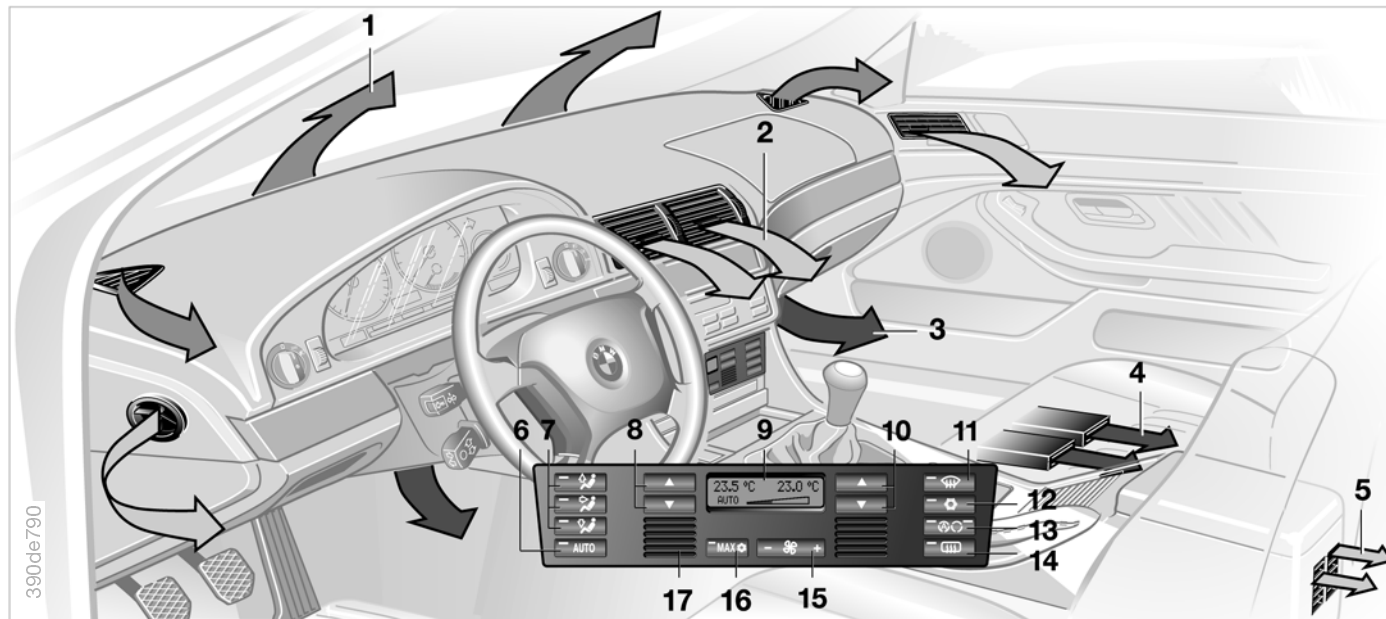

10 Temperature – right side 116
 11 Defrosting and demisting windows 116
 12 Air conditioning 117

13 Automatic Recirculated Air Control (AUC) 117
 14 Heated rear window 118
 15 Air supply 116

16 Maximum cooling effect or use of residual heat 117 or 118
 17 Air inlet grille for interior temperature sensor – keep unobstructed

390de790

A pleasant interior temperature

Use the automatic system, i.e. switch on AUTO button 6. Select the interior temperature which you find most agreeable.

The description below tells you how to obtain various settings which may be individually preferred.





When your car is unlocked with the remote control using a personal key, your preferred air conditioning settings will be restored automatically. ◀

Automatic air distribution

The AUTO program handles the setting of air distribution for you and also adapts your temperature preferences to suit ambient conditions (summer, winter).

Individual air distribution

You can also select your preferred combination of air distribution settings and thus switch off the AUTO program; the automatic air supply, however, is automatically maintained. Air flows on to the windows , to the upper body zone  and to the footwell . However, you can switch the automatic air distribution back on by pressing the AUTO button.

Temperature

You can also select your own individual temperature setting on the driver's and front passenger's sides of the car. The displayed values are a guide to the actual interior temperature. 22 °C is recommended as a pleasant setting, whether or not the air conditioning is in operation. During the journey, the chosen temperature is reached as quickly as possible – in summer and in winter – and maintained at a constant value.

Air supply

In the AUTO program, air supply is controlled automatically; AUTO appears in display 9 – see the summary on page 114. Using "+" and "-" you can vary the air supply. Your entry is indicated by a bar display, the automatic air supply is switched off and the automatic airflow distribution system remains unchanged. However, you can switch the automatic air supply system back on by pressing the AUTO button.

In the lowest fan setting, if you press "-", all displays disappear: the blower, heater and air conditioning are switched off and the air supply is closed. The automatic air conditioning can be switched on again by pressing any button (except MAX button 16).

Defrosting and demisting windows

This program removes ice and condensation quickly from the windscreen and from the side windows.

Automatic air conditioning

Air conditioning



Air is cooled and dried when the air conditioning is switched on, then is heated back up to suit the temperature setting. Depending on weather conditions, the windscreen may fog over momentarily when the engine is started. Switching on the air conditioning system reduces this effect.



Moisture condensate forms in the air conditioning and is discharged underneath the car. Traces of water on the ground are therefore normal. ◀

Maximum cooling effect



This program enables you rapidly to achieve maximum cooling effect when the engine is running, at outside temperatures of approx. 5 °C upwards.

The temperature displays 9 jump to 16 °C, the system switches to the recirculated-air mode and air emerges at the maximum flow rate from the ventilation grilles only. Be sure to keep these grilles open when you select this program.

Automatic Recirculated Air Control (AUC)



If the air outside the car has an unpleasant odour or contains pollutants, you can shut off the supply to the interior of the car temporarily. The air inside the car is then recirculated. Obtain the desired operating mode by pressing the button as often as necessary.

- ▷ Indicator lights off: airflow from outside the car
- ▷ Left indicator light on – AUC operation: the system identifies pollutants in the outside air and shuts off the supply if necessary. The air inside the car is then recirculated. After this, the automatic system switches between outside air supply and recirculated air according to the available air quality
- ▷ Right indicator light on: the outside air supply is permanently shut off. The air inside the car is recirculated.

If your car has a multifunctional steering wheel with recirculated air switch (see page 20), you can use it to change between "Off" and the recirculated air mode (or between AUC and the recirculated air mode).



If the windows mist up in recirculated mode, switch this mode off and, if necessary, also increase the air supply. ◀

Heated rear window



When the heated rear window is switched on, the indicator light comes on. The heated rear window switches itself off automatically.

Residual heat utilisation



Heat from the engine is stored and used to heat the car's interior when the ignition is switched off, for instance when waiting at a level crossing.

In ignition key position 1, you can alter the automatic air conditioning settings. In ignition key position 0, the heated air is directed automatically to the windscreen, side windows and footwells.



This function can be activated if the outside temperature is below approx. 15 °C, the engine is at its regular operating temperature and the battery is sufficiently charged. The LED in the button comes on if all these conditions are met. ◀

Auxiliary heater

BMW 520d, 525d, 530d:
When the engine is cold, there is a fuel-burning auxiliary heater for warming up the car's interior more rapidly. Its exhaust fumes are discharged under the door sill on the driver's side. If the engine is stopped before it has reached its regular operating temperature, the auxiliary heater continues to run for a short time, and therefore produces exhaust fumes.

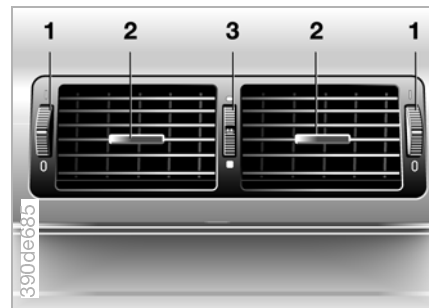

Draught-free ventilation

The outlets for the occupants' upper body area can be adjusted to suit your personal preferences:

- 1 Knurled wheels for opening and closing the air outlets continuously
- 2 Levers for altering the airflow angle
- 3 The knurled wheel allows you to vary the temperature of the airflow:
 - ▷ Turn towards the blue mark – cooler
 - ▷ Turn towards the red mark – warmer.

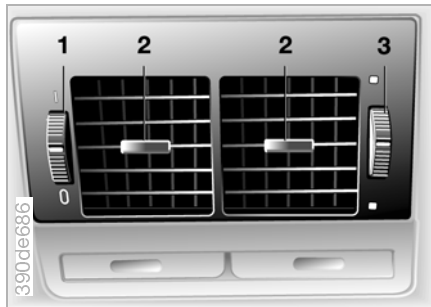

Rear-seat area ventilation

- 1 Knurled wheel for opening and closing the air outlets continuously
- 2 Levers for altering the airflow angle
- 3 Use knurled wheel to vary the temperature of the airflow, subject to the position of the knurled wheel at the front of the car.

Micro-filter and activated charcoal filter

The micro-filter traps dust and pollen in the incoming airflow. The activated charcoal filter in addition removes gaseous pollutants from the air entering the car. This combined filter is changed by BMW Service during routine maintenance work. If the airflow is noticeably less than usual, this may indicate that the filter should be renewed earlier.

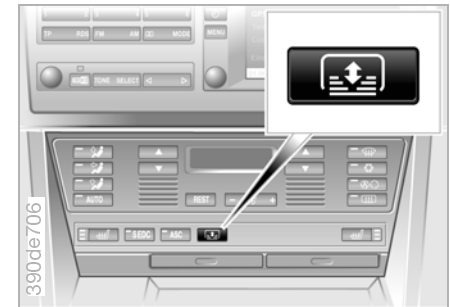

From ignition key position 1, press the button to operate.

Roller sun blinds for rear side windows*

Pull the blind out at its loop and secure it to the retainer.

If your car has an auxiliary fuel-burning heater, it is also equipped with independent ventilation control. Cars are also supplied with independent ventilation control only.

Both systems are operated via the Multi-Information Display (MID) (see page 88) or the on-board computer. There is a separate Owner's Handbook for the on-board computer.

Two different switch-on times can be preselected, so that you can be sure that the car's interior is warm when it is next entered. Snow and ice are also easier to remove from the windows.

The auxiliary heater runs for 30 minutes. It can also be switched on and off directly. Since its current consumption is high, it should not be run twice in succession unless there has in the meantime been an opportunity to recharge the car's battery by driving the car.

The auxiliary fuel-burning heater can be operated at outside temperatures below 16 °C if the switch-on time is preselected, or switched on directly at any outside temperature. This only applies when the car is driven, however, until the engine has reached its regular operating temperature.

The heated air is directed automatically to the windscreen, side windows and footwell; maximum heating output is always used.

In ignition key position 1 you can adjust the interior temperature, air supply and air distribution.

The auxiliary heater continues to run for a short period after it has been switched off (indicator light out).



Even during the warm season of the year the auxiliary heater should be switched on directly about once a month, then switched off again after about 5 minutes. ◀



Do not operate the auxiliary heater in confined spaces (closed rooms). Always switch off the auxiliary heater before refuelling the car. ◀

Independent ventilation*

Ventilates the interior of the car and lowers its temperature by means of the (automatic) air conditioning blower.

The independent ventilation control is operated via the Multi-Information Display (MID) (see page 88) or the on-board computer. There is a separate Owner's Handbook for the on-board computer.

Two different switch-on times can be preselected; the ventilation system then runs for 30 minutes. It can also be switched on and off directly. Since its current consumption is high, it should not be run twice in succession unless there has in the meantime been an opportunity to recharge the car's battery by driving the car.

Independent ventilation control can be operated at any outside temperature above 16 °C if the switch-on time is preselected, or switched on directly at any outside temperature, but not when the car is being driven.

Air emerges from the variable-flow, controlled-direction outlets for the upper body zone on the fascia. These outlets must therefore remain open if the independent ventilation system is to be used.

In ignition key position 1, the airflow volume and air distribution are adjusted in the same way as for auxiliary heating.

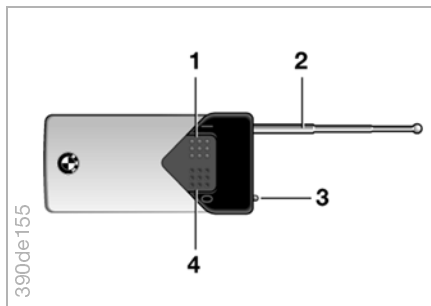

1 Switching on

2 Radio aerial

3 Indicator light

4 Switching off

You can switch the auxiliary heater on and off with the remote control handset provided that the outside temperature is below 16 °C. The reception signals are sufficiently strong for the remote control to operate on average at a range of up to 350 m (approx. 1,150 ft).

Switching on

1. Extend aerial 2 fully
2. Press button 1. Indicator light 3 flashes three times, then emits short rhythmic flashes for the remainder of the operating period (max. 30 minutes)
3. Push the aerial back in, but only after the first three regular flashes have been seen.

Switching off

1. Extend aerial 2 fully
 2. Press button 4. The indicator light 3 flashes three times and then goes out
 3. Finally, push the aerial back in.
- Renewing the battery and operating a new transmitter: see page 166.

 The best signal transmission is obtained if the remote control is held either vertical or horizontal. When switching on and off, do not touch the aerial or point it at the car. The remote control only operates the auxiliary heater if this is not already running after a preselected time input or direct switch-on. ◀

Interference

Operation of the remote control may be interfered with by outside equipment operating on the same frequency.

The principle

The integrated universal remote control replaces up to three hand-held remote controls for various other systems or devices, for example a gate opener, alarm or door locking system. The integrated universal remote control identifies and "learns" the signals transmitted by the original control devices.

The signal from an original hand-held remote control can be programmed to one of the three channel buttons. After this, the programmed channel button will operate the system in question. Transmission of the signal is shown by the indicator light.

Before selling the car, the channel buttons should be erased, as described on page 124.



During the programming operation and before a programmed system is operated with the integrated universal remote control, make sure that no persons, animals or objects are within the system's range of movement, in order to avoid possible injury or damage. Comply also with the safety instructions supplied with the original remote control. ◀

The original hand-held remote control

If this symbol appears on the pack or in the instructions supplied with the original remote control, you can assume that it will be compatible with the integrated universal remote control.

Checking for alternating code

To check whether the original handheld remote control is equipped with an alternating code system, either study the instructions supplied with it or program a channel button as described on page 123, left-hand column, under the heading "Programming".

After this, hold down the programmed channel button on the integrated universal remote control. If the indicator light on the integrated universal remote control flashes rapidly for two seconds and then remains on, the original control device uses an alternating code. In this case, program the channel buttons as described on page 123, right-hand column under the heading "Programming an alternating-code transmitter".



If you have any queries in this connection, please contact BMW Service. ◀

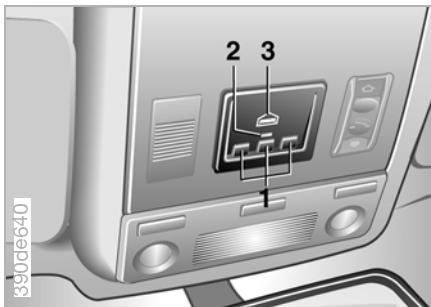

Programming

- 1 Channel buttons
- 2 Indicator light
- 3 Receiver for programming

 Comply with the safety precautions on page 122. ◀

1. Ignition key position 2
2. Initial start-up: press both outer buttons 1 until indicator light 2 flashes, then release them. This will deactivate the three channel buttons

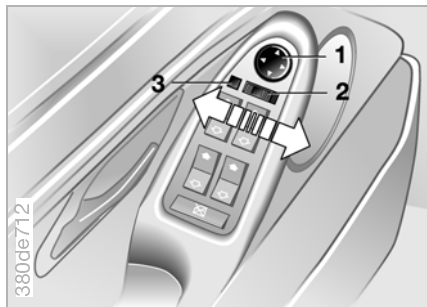

3. Hold the original handheld transmitter against receiver 3 (not more than 5 cm/2 in away)
4. Press the command button on the original transmitter (arrow 2) and the desired channel button on the integrated universal remote control (arrow 1) at the same time. Release both buttons when the indicator light flashes rapidly
5. To program additional original transmitters, repeat steps 3 and 4.

The channel buttons you have chosen are then programmed with the signal from the corresponding original handheld transmitters.

Programming an alternating-code transmitter

 Comply with the safety precautions on page 122. ◀

When programming the integrated universal remote control, consult the operating instructions for the device in question. To use the integrated universal remote control with an alternating-code system, the following additional programming instructions must be complied with:

 If a second person is available, this will simplify programming of the integrated universal remote control. ◀

1. First program the integrated universal remote control as described above in "Programming"
2. Keep the programming button at the receiver pressed in for about two seconds, until the programming light on the unit's own device comes on
3. Press the chosen channel button on the integrated universal remote control three times.

 If you have any queries in this connection, please contact BMW Service.◀

Deactivating the channel buttons

 Comply with the safety precautions on page 122.◀

Individual channel buttons cannot be deactivated. Only all three channel buttons together can be deactivated together as follows:

- ▷ Press the two outer channel buttons of the integrated universal remote control until the indicator light flashes, then release them.

All channel buttons are then erased.

Glove box

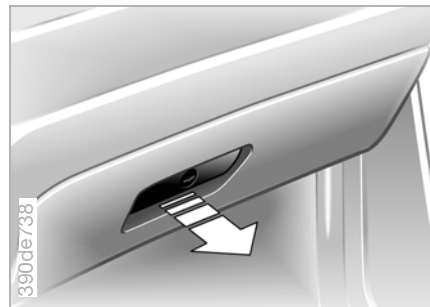

To open

Pull the handle. The light in the glove box comes on.

To close

Swing the lid up.

 After using the glove box, close its lid without delay, so that it cannot cause injury in the event of an accident.◀

Glove box

To lock

Lock with a master key. The glove box can only be unlocked with a master key.

 If you only hand over the door key and ignition key, for example to hotel staff (see page 32), this will prevent unauthorised access to the glove box. ◀

Rechargeable hand lamp*

This is inside the glove box, on the left. The lamp is protected against over-charging and can therefore remain in the socket when it is not in use.

 Always switch the lamp off before inserting it into the socket, or else the car's battery could be drained and damaged. ◀

Storage compartments



The lid of the compartment on the front, inclined section of the centre console can be slid open and closed (arrow). If a cassette holder* is installed, each cassette compartment is opened by pressing the small button next to it.

Compartment on centre console between front seats: to open, reach into the recess and pull up. If a car phone is installed, it will occupy this compartment.

There is an open storage compartment to the left of the steering column.

There is further storage space in all doors and on the front seat backs*.

Car phone*

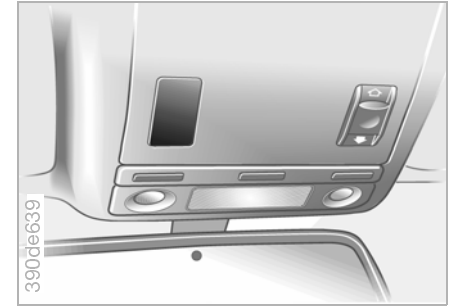

Hands-free telephone system*

On cars prepared for telephone installation* there is a trim panel for the hands-free microphone in the roof lining, near the interior light.

For further information on the car phone, see the separate operating instructions.

Drinks can holders*

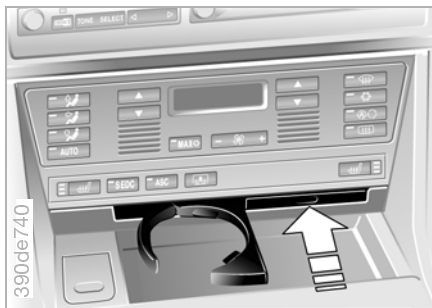

There are two drinks can holders at the front of the centre console (illustration). Press briefly to release and open them; swing back inwards when not required.

Front ashtray*

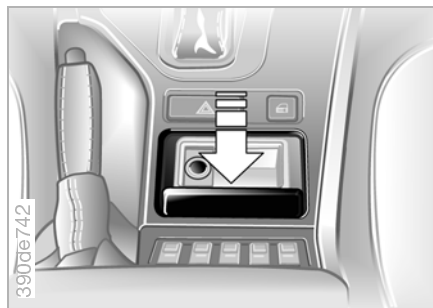

To empty

Press the edge of the lid (arrow): the ashtray will pop up and can be removed.

On cars with non-smoker fittings, the insert is removed in the same way.

Cigarette lighter*

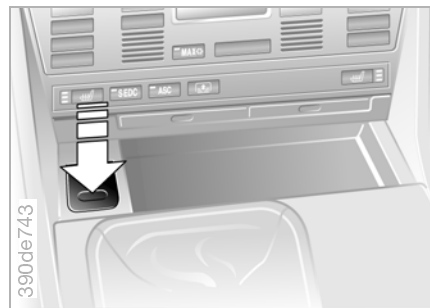

Press the recess (arrow) briefly, then press the cigarette lighter in.

The cigarette lighter can be removed when it pops back out.



Hold the hot cigarette lighter only by its knob, otherwise you may suffer burns.

The cigarette lighter remains operational when the ignition key has been removed. For this reason, do not leave children in the car unattended. ◀

Cigarette lighter*

Cigarette lighter socket

This can also be used for a 12 Volt hand lamp, car vacuum cleaner or similar appliance rated at up to approx. 200 Watts. Make sure that the socket is not damaged by attempting to insert plugs of the wrong pattern.

Non-smoker package

In cars with non-smoker equipment, the socket is protected by a cap.

Access to socket: pull off the cap.

Rear ashtray*

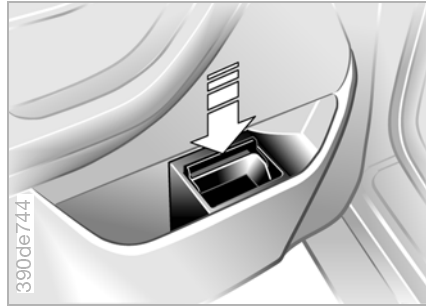

To empty

Press the edge of the lid (arrow): the ashtray will pop up and can be removed.

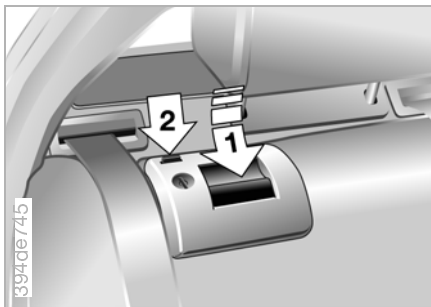

Folding rear seat back

Reach into the recess and pull forward (arrow 1).

When the seat backs are returned to the raised position again, make sure that their catches engage correctly. The red panel (arrow 2) must move down.

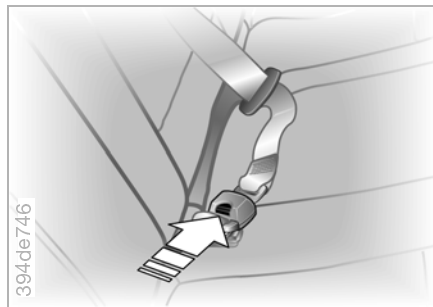

The centre seat belt has a small additional belt lock.

- ▷ If you connect up the two belt sections, you can use the centre seat belt just like any normal three-point seat belt
- ▷ Disconnecting the seat belt (arrow) makes it more convenient to fold down the larger seat back.

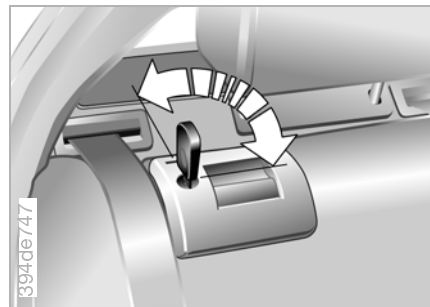

Each seat back can be locked with one of the car's master keys.

This prevents access to the luggage compartment from the inside of the car if you are obliged to hand over door and ignition key 3 (see page 32). This is an advantage e.g. in hotels.

Ski bag*

This enables up to four pairs of standard skis or up to two snowboards to be carried safely and kept clean.

Using the full length of the ski bag and the additional space in the luggage compartment, skis up to a length of 2.10 m (approx. 7 ft) can be carried. If skis of this length are carried, however, the ski bag will only be able to hold two pairs before it becomes too narrow.

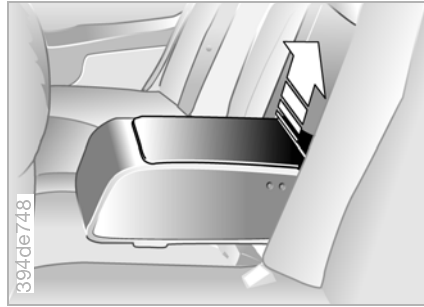

Installing the centre armrest

Insert the centre armrest from the top and press it down until it is heard to engage in its holders.

 Make sure that the pins at the sides do not damage the seat upholstery. ◀

Removing the centre armrest

(Not on cars with through-loading system or on touring; see page 131.)

1. Unfold the centre armrest completely
2. Detach the cover over the opening at the top (it has a burr fastener) and place it on the armrest
3. Hold the front of the armrest with one hand, place the other hand under the armrest and move it sharply upwards (arrow).

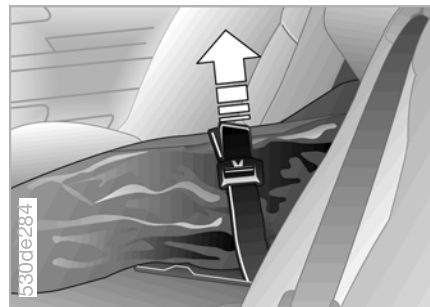
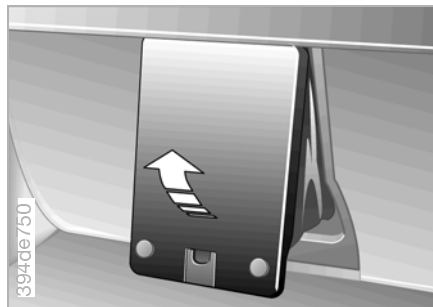
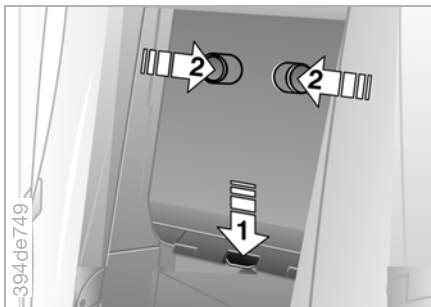

Loading

1. Press the button (arrow 1); this will unlock the loading flap in the luggage compartment
2. Press the locking levers together (arrows 2) and swing the cover forwards
3. Lay out the ski bag between the front seats. The zip fastener simplifies access to the contents of the bag, and makes drying it out easier

4. Inside the luggage compartment, secure the loading flap to the underside of the rear window shelf with the magnetic retainers.

To stow away the ski bag, follow the opposite procedure.

Securing the load

- ▶ Secure the skis or any other stored objects with the retaining strap on the ski bag. Tighten the turn-buckle to ensure that the retaining strap is taut. ◀

Make sure that the skis are clean before they are inserted into the bag, and that any sharp edges on them or their bindings do not damage or pierce the ski bag.

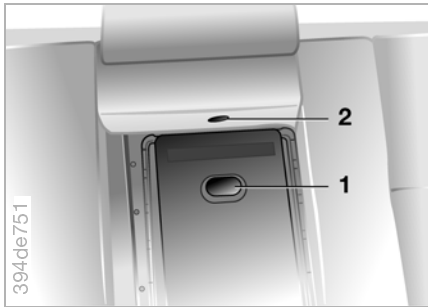

With through-loading system

1. Swing out the centre armrest, detach the cover over the opening at the top (it is secured by a burr fastener) and place it on the armrest
2. Press catch 1 down and swing the cover forwards
3. Press catch button 2: this unlocks the flap in the luggage compartment.

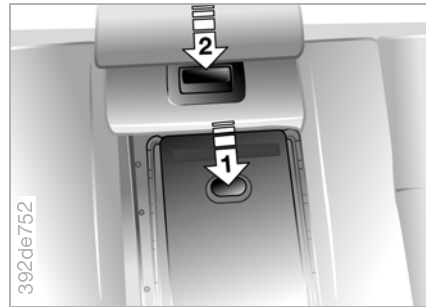

In the touring

1. Swing out the centre armrest, detach the cover over the opening at the top (it is secured by a burr fastener) and place it on the armrest
2. Press catch 1 down and swing the cover forwards
3. Press the catch 2: this releases the flap in the load area.

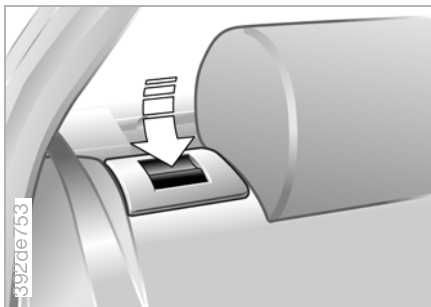

Folding rear seat back

Reach into the recess and pull forward (arrow).

The rear seat back is divided into two sections, one of them one-third and the other two-thirds of the total width. You can fold down both sides to enlarge the luggage area.

 When the seat backs are returned to the raised position again, make sure that their catches engage correctly. The red warning zone in the recess then disappears.

The centre seat belt can only be pulled out when the larger section of the rear seat back is locked into position. ◀

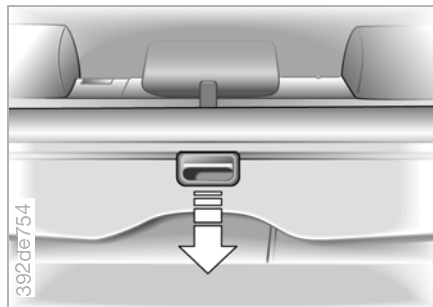

Roller-blind cover

Pull out the roller cover and secure it in the retainers at the back.

The cover can support the weight of light articles, e.g. clothing.

 Do not place hard or heavy objects on the roller cover, since they could endanger the car's occupants in the event of sudden braking or avoidance action.

Do not allow the roller cover to run back too fast, as this could damage it. ◀

For storage of the roller cover, see next page.

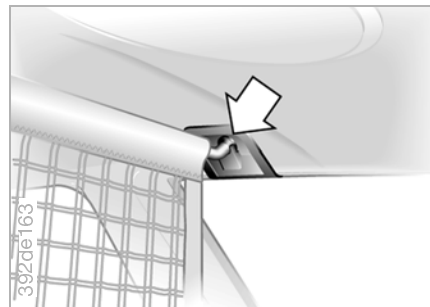

Protective net

Pull out the protective net by the loop, holding the rod with your other hand. Now grip both ends of the rod, pull upwards and locate it in the retainers. This is best done from the back seat.

 Do not allow the protective net to retract too fast, or it could cause injury and itself become damaged. ◀

When the rear seat backs are folded, the net tube can be secured in front of the rear seats, from which point the net can still be pulled out and secured at the front retainers (see next page).

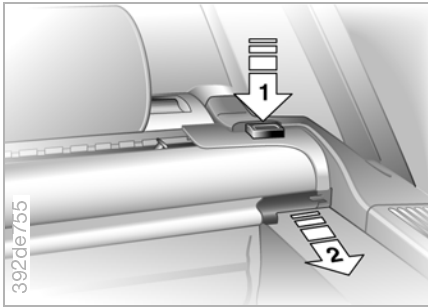

Removing roller cover and protective net

1. Press the buttons (arrow 1) to release the cover casing at both sides
2. Pull the casing out to the rear (arrow 2), but avoid tilting it.

Installing

Simply insert the tube into the two side holders and push it forward until it engages.



Storage

Holders for the tube are provided in front of the rear seat.

Insert the tube from the right, as shown in the picture. The loop on the protective net must be at the top and the end of the roller cover must be placed around the tube at the bottom rear.

You can pull out the protective net and insert it in the brackets above it in the roof area.

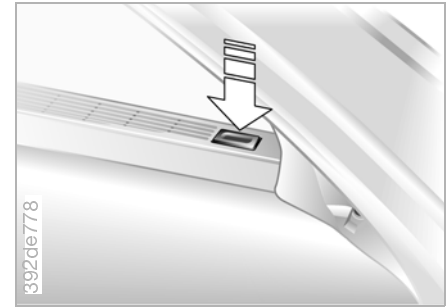

Side flaps

To open, press the button.

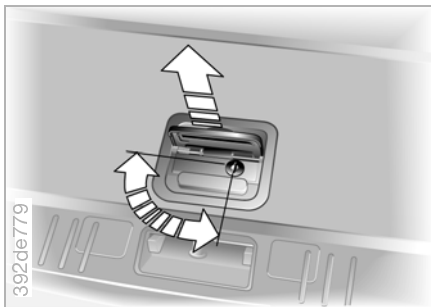

Compartment in floor

To open: press the recessed section of the handle and swing up the flap (large arrow).

The flap is lockable with a master key.

The partitions in the compartment can be repositioned. If they are removed and their holders turned to the left and taken out, a compartment with a flat floor is obtained.

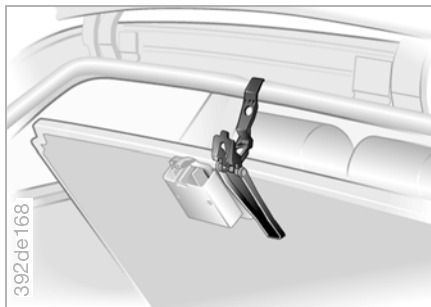

Raising the floor panel flap

Swing up the catch (black) on the underside of the flap and attach it to the upper frame of the tailgate cutout.

Before folding the floor panel flap down again, return the catch to its original position.

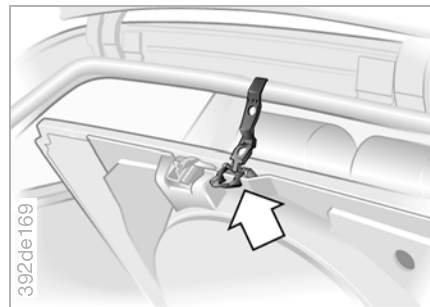

Raising the spare wheel cover

Swing the cover up and attach it to the red catch on the floor panel flap (arrow). Before folding the cover back down, return the catch to its original position.

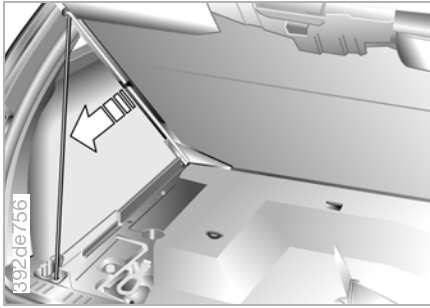

Raising the load-area floor

For access to the area under the floor, the spare wheel etc.:

- ▷ Swing up the load-area floor panel and retain it with the rod (arrow)
- ▷ Open the quick-release fasteners on the spare wheel cover.

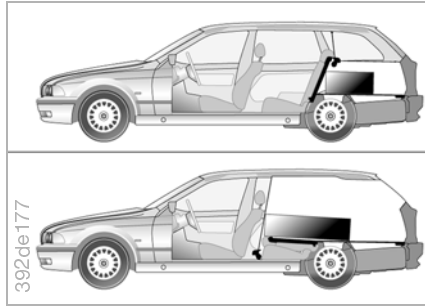

Loading

If you carry heavy or bulky loads in your BMW:

- ▷ Place heavy loads as far forward as possible – right behind the back rests or the load area partition – and keep load low (illustration shows the touring)
- ▷ Wrap protective material round sharp corners and edges
- ▷ Do not stack loads higher than the seat backs
- ▷ Pull out the protective net* (see page 132), making sure that no objects can penetrate the net

- ▷ When carrying very heavy loads with no passengers on the back seat, insert each of the outer seat belts into their opposite locks.



Securing the load

- ▷ Small and light items can be retained with the tensioning straps, a load-area net* or other suitable straps (see page 43)
- ▷ BMW Service can supply suitable means of lashing and securing larger or heavier loads*. Lashing points are provided in the corners of the luggage compartment or load area (illustration shows the touring)
- ▷ Please note the information supplied with load securing equipment.

 Always stow and secure the load correctly, so that it cannot endanger the car's occupants in the event of sudden braking or avoiding action being taken.

Do not exceed the car's gross weight limit or the permissible axle loads (see page 185), otherwise the car's operating safety may be endangered and the construction and use regulations infringed.

Heavy or hard objects should not be carried loose inside the car, since they could be dislodged by heavy braking, sudden avoiding action or similar and endanger the occupants. ◀

Roof rack*

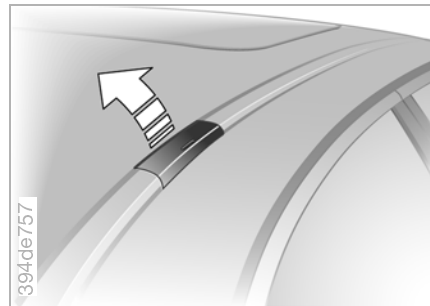

A special roof rack system is available as an accessory for your BMW. If it is used, please comply with the installation instructions supplied.

Mounting points

Access to the mounting points:
To open the covers (arrow), use the tool accompanying the roof rack system.

Loading and driving hints

A loaded roof rack alters the car's road behaviour and steering response quite considerably, by moving its centre of gravity.

Roof rack*

When loading the roof rack, ensure that the specified roof load limit, the car's gross weight limit and the axle loads are not exceeded.

The relevant figures are shown in "Technical data", page 185.

The roof load must be uniformly distributed and should not be too large in area. Heavy items of luggage should always be placed at the bottom. Make sure that sufficient clearance is available for raising the sliding/tilt sunroof and that no objects extend into the hinge-up area of the tailgate.

 Fasten loads to the roof rack securely, as they could endanger following traffic if they shift or fall off during the journey. ◀

Drive smoothly and avoid violent acceleration, braking or cornering.

Towing a trailer

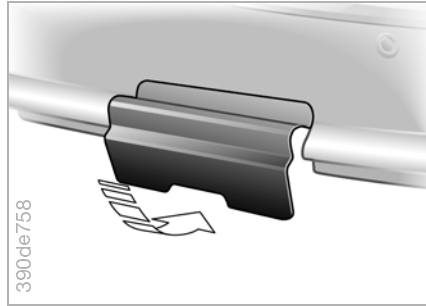

Cover flap*

Removing

Take hold of the trailer tow hitch cover panel in the cutout provided, pull downwards and to the rear and remove the panel from the cutout.

For attaching and removing the ball head, please see the separate instructions.

Fitting

First install the cover flap at the top with the groove in the aperture, then press in the lower area (arrow).

Trailer tow hitch*

The suspension settings of your BMW afford optimum safety, ride comfort and sports performance.

If a trailer tow hitch has been fitted by the manufacturer, the vehicle will also be equipped with uprated suspension* at the rear as standard. This compensates for the weight of the tow hitch and also ensures optimum road behaviour when the trailer is not being towed.

If a trailer tow hitch* is retrofitted, it must be of a type approved by BMW and be expertly installed by BMW Service. You are recommended to have uprated suspension fitted as well. On models with self-levelling suspension, the trailer-towing suspension need not be retrofitted.

BMW does not approve of any other suspension systems offered by the automotive trade for trailer towing purposes.

Look after a detachable ball end in accordance with its manufacturer's operating instructions, to ensure that it can be fitted and removed without difficulty.



If a trailer tow hitch is installed, the self-regenerating action of the rear bumper system may not be able to take effect. ◀

The use of a stabilising device can be recommended, particularly if the trailer is a heavy one. Information can be obtained from BMW Service.

Nose weight

This is the weight which the trailer towbar exerts downwards on the ball head of the car's trailer tow hitch (it can for example be measured with bathroom scales).

In Germany: a minimum nose weight of 25 kg (55 lb) is laid down by law.

The nose weight limit (see page 185) may not be exceeded, but should always be utilised to the full, in particular when towing large, heavy trailers which are prone to swinging from side to side.

The trailer's nose weight affects the towing vehicle, and must not lead to the car's gross weight limit or rear axle load limit being exceeded if a trailer is being towed. The car's payload limit is reduced by the weight of the trailer tow hitch and, if a trailer is being towed, by its nose weight. The gross weight limit for the combined car and trailer must not be exceeded.

Towing a trailer

The permissible trailer load and nose weight (towbar downthrust) are stated in "Technical data", page 185. The trailer load limit is also entered in the car's registration papers. Consult BMW Service regarding increased trailer weights.

Loads:

When loading the trailer, make sure that the weight is kept as low down as possible and stowed if possible close to the axle.

A low centre of trailer gravity makes the outfit much more stable and safe to drive.

Do not exceed either the trailer's gross weight or the specified trailer load limit for the car. The smaller value is the limit which should be adhered to.

Before purchasing a trailer it is advisable to obtain a declaration from the trailer manufacturer concerning the effective trailer weight and trailer payload limit.

Towing a trailer

Gradients:

In the interests of safety and to avoid holding up other traffic, do not attempt to climb gradients steeper than 12%. If an application is made to tow a heavier trailer, the limit is 8%.

 **BMW 520d, 525d, 530d:** On vehicles with automatic transmission, engage position "D" when climbing long inclines, otherwise bubbles may form in the fuel as a result of overheating, causing the engine to stall. ◀

Downhill gradients:

Special care must be taken when descending gradients, as a trailer is more susceptible to snaking. Always shift down to the next-lower gear before downhill gradients – or as far down as 1st gear if necessary – and drive down the hill slowly.

Speed limit:

The maximum speed limit when towing a trailer is 80 km/h (50 mph) in Germany, and similar speed limits apply in other countries also.

If the trailer begins to snake, the outfit can only be stabilised by braking hard immediately. Only attempt to steer out of the situation if this is absolutely essential; make any steering movements as gently as possible.

Tyre pressures:

Check the car's and the trailer's tyre pressures most carefully. For the trailer, comply with the manufacturer's recommendations.

Outside mirrors:

Two outside mirrors which bring both rear corners of the trailer into your field of view are required by law. Mirrors of this kind can be obtained from BMW Service.

Electrical system

 Higher electrical consumption can be expected if a trailer (caravan) is towed. Try to avoid operating electrical equipment for too long at a time, in order to limit the drain on the car's battery. ◀

 Before starting a journey, check that the trailer's rear lights are operating correctly. ◀





Initial overview

Controls in detail

Operation, maintenance

Minor repairs

Technical data

Index

Overview

Controls

Maintenance

Minor repairs

Data

Keywords

Please comply with the following instructions, which are intended to ensure that your car achieves its optimum operating life and economy.

Engine and final drive

Up to 2,000 km (approx. 1,300 miles): drive at varying road and engine speeds, but do not exceed the following maximum values:

- ▷ Cars with spark-ignition (petrol) engine
 - 6-cylinder: 4,500 rpm
or 160 km/h (100 mph)
 - 8-cylinder: 4,500 rpm
or 170 km/h (105 mph)
- ▷ Cars with diesel engine
 - 3,500 rpm
or 150 km/h (93 mph)

Observe the national speed limits.

Avoid full throttle and do not use the automatic transmission "kick-down".

From a distance reading of 2,000 km (approx. 1,300 miles) onwards, engine and road speeds can be gradually increased.

Comply with these running-in instructions again if an exchange engine or final drive is fitted later in the car's life.

Tyres

New tyres do not achieve their full road grip immediately, for production reasons. You should therefore drive in a restrained manner for the first 300 km (approx. 200 miles).

Braking system

Brake pads and discs do not achieve a favourable wear and contact pattern until the car has covered about 500 km (approx. 300 miles).

Clutch

The clutch likewise needs to be run in for about 500 km (approx. 300 miles) before it will operate with maximum efficiency. Operate the clutch gently while running it in.

Driving hints



Brakes:

Do not rest your foot on the brake pedal while the car is in motion. Even slight continuous pressure on the brake pedal could cause overheating, brake pad wear or even brake system failure. Aquaplaning:

When driving on wet or slushy surfaces, reduce speed to prevent a wedge of water from forming between the tyre and the road. This situation, known as aquaplaning, means that the tyre can actually lose contact completely with the road surface, so that the car can neither be steered nor can the brakes be properly applied.

Water on the road:

When there is water on the roads, drive through it only to a max. depth of 30 cm (approx. 12 in), and no faster than walking pace, otherwise the engine, electrical system and transmission may be damaged.

Driving hints

Rear-window shelf:

Do not leave any heavy or hard objects on the shelf, as they could be dislodged by heavy braking or a sudden avoidance manoeuvre, and endanger the car's occupants.

Coat hooks:

Items of clothing hung from the hooks must not obstruct the driver's view. Do not hang any heavy objects from the hooks, as these could endanger the car's occupants in the event of heavy braking or a sudden avoidance manoeuvre. ◀

Anti-lock brake system (ABS)

The principle

The antilock brake system (ABS) prevents the wheels from locking when the brakes are applied, and thus increases active safety.

Braking with ABS

You use ABS most effectively by applying maximum brake pressure in situations which call for this ("full braking"). Since the vehicle remains steerable, you can avoid obstacles by turning the steering wheel as smoothly as possible.

The pulsating sensation at the brake pedal, combined with the sound of the hydraulic system operating, indicates that ABS is intervening.

Brake fluid level

If the brake fluid level is too low and if brake pedal travel is much greater than usual, one of the two hydraulic brake circuits may have failed.

 Visit your nearest BMW Service. Increased brake pedal pressure may be necessary, the car may "pull" to one side and longer braking distances may be required. Modify your driving style accordingly. ◀

Disc brakes

If the car covers only short distances, stands out of use for lengthy periods and is only used infrequently or gently, corrosion and dirt will affect the brake discs and pads more severely, because the minimum loads needed to achieve the desired self-cleaning effect of the disc brakes have not been reached.

When the brakes are applied, corroded discs tend to judder, and even lengthy brake applications usually fail to eliminate this effect entirely.

In wet conditions or heavy rain, it is a good idea to apply the brakes lightly from time to time. When doing so, make sure that no other road-user is endangered. The resulting heat dries the brake discs and pads. The full braking effect will then be immediately available if required.

You should select the gear which calls for the least use of the brakes when descending long or steep hills. This avoids overburdening the brakes and therefore the risk of brake fade.



Never drive with the clutch pedal held down, with the gear lever or selector lever in neutral or with the engine switched off; engine braking action will not be present with the gearbox or transmission in neutral and there will be no power assistance to the brakes or steering while the engine is switched off.

Make sure that the full travel of the brake, clutch and accelerator pedals is not obstructed by floor mats, carpets or other objects. ◀

Brake pads

In the interests of your own safety, use only brake pads approved by BMW for use on a specified type of vehicle. If BMW has not approved the brake pads it cannot assess their suitability or provide any guarantee of road safety. ◀

Tyre pressures

Information for your safety

The radial-ply tyres approved for your car are matched to its characteristics and ensure not only optimum road safety but also the desired level of ride comfort.

The condition of the tyres and maintenance of the correct tyre pressures not only influence tyre life but are also decisive factors in ride quality and above all in road safety.

! Incorrect pressures are often a cause of tyre problems. They also have a considerable effect on the road-holding of your BMW. Check tyre pressures – including the spare wheel – on a regular basis (see page 24), but at least twice a month and before setting out on any long journeys. Incorrect tyre pressures can adversely affect the car's roadholding and cause tyre damage, which could result in an accident. ◀

Condition of tyres



Tyre tread – tyre damage

Inspect the tyres frequently for damage, the presence of foreign bodies, unusual wear and sufficient tread depth.

Tread depth should if possible not be allowed to drop below 3 mm (approx. 0.12 in), even though a minimum tread depth of only 1.6 mm (approx. 0.06 in) is required by law. Wear indicators (arrow) in the base of the tread groove, the distribution of which is indicated on the tyre's shoulder with TWI (Tread Wear Indicator) indicate when a tread depth of 1.6 mm (approx. 0.06 in) has been reached; this is the legal limit for tyre wear. Below a tread depth of 3 mm (approx. 0.12 in) there is a risk of aquaplaning at fairly high road speeds even if the water is not very deep.

! Never continue driving with a flat tyre. If air pressure is lost from a tyre, this seriously affects the car's handling and braking, and could cause the driver to lose control. Avoid overloading the car, as this could cause the tyres' load capacity limit to be exceeded. Otherwise you could overheat the tyres and cause internal damage to them in the short to medium term. In some cases, this can result in sudden loss of tyre pressure. Unusual vibration while the car is being driven could indicate a tyre fault or some other defect on your car. This may occur e.g. when driving over a kerb or similar. The same applies to any other abnormal road behaviour, such as pulling severely to the right or left. In such cases, reduce speed immediately. Proceed carefully to the nearest BMW Service or tyre dealer, or have the car towed there so that it can be checked or its tyres or wheels inspected. All forms of tyre damage (which could in the worst case lead to sudden and total loss of pressure) represent a risk of serious or even fatal injury to the car's occupants and to all other road users. ◀

To maintain the car's good road behaviour, always fit tyres of the same make and tread pattern to all wheels. BMW tests and approves combinations of wheels/tyres for use on your car.

 Do not use retreaded tyres, as these could have adverse effects on the car's safety. Their carcasses may differ in internal construction or have aged sufficiently to cast doubt on their durability. ◀

Age of tyres

A tyre's date of manufacture is shown as part of the inscription on the tyre wall:

DOT ... 2501 means for instance that the tyre was manufactured in Week 25 of the year 2001.

BMW recommends tyre replacement after not more than 6 years, even if tyres up to 10 years old may still be suitable.

Wheel and tyre combinations

Choosing the correct tyres

 Fit only wheels and tyres that have been approved by BMW for your type of vehicle, otherwise the tyres may e.g. make contact with the vehicle body due to impermissible tolerances, even though they are of an approved size; this could result in a serious accident. BMW is unable to assess the suitability of wheels and tyres it has not approved and cannot therefore guarantee their safety. ◀

BMW has tested certain makes of tyre for each tyre size, classified them as safe for use and approved them. BMW Service is able to provide the details of these makes. Observe any national legislation e.g. on entries required in the vehicle documents

 The correct wheel and tyre combination has an influence on various systems, the function of which could otherwise be adversely affected, for instance ABS, AGS, ASC+T/DSC. For this reason, fit only tyres of the same make and tread pattern on all the car's wheels, and after a puncture, for instance, fit the approved wheel and tyre combination again as soon as possible. ◀

Tyre storage

Store wheels and tyres in a cool, dry and preferably dark place when not in use. Protect tyres against contamination from oil, grease and fuel.

The correct tyres

BMW recommends you to fit winter tyres (M+S radial-ply) if the car is used for driving in wintery conditions. Although tyres sold for all-year use with an M+S marking have better winter characteristics than summer tyres marked with speed letters H, V, W, Y or ZR, they do not normally match the performance of winter tyres.

In the interests of reliable directional stability and steerability, fit winter tyres of the same make and tread pattern to all four road wheels.

Note the speed limit applicable to these tyres

In Germany: a sticker stating the maximum permitted speed must be displayed in the driver's field of view if the car is capable of speeds higher than that permitted for the tyres. Suitable labels are available from tyre suppliers or a BMW Service.



Never exceed the maximum speed laid down for the winter tyres fitted to your car.

Lack of expert knowledge or incorrect handling of tyres can cause damage and lead to accidents.

All work on tyres should therefore be carried out only by experts. BMW Service will gladly place its specialised knowledge and facilities at your disposal. ◀

Tyre condition and tyre pressures

Below a tread depth of 4 mm (0.16 in), winter tyres become noticeably less suitable for winter driving conditions and should therefore be replaced for safety reasons.

Keep to the specified tyre pressures and have the wheels and tyres rebalanced each time the wheels are changed or new tyres are fitted.

Fine-link BMW snow chains are only permitted if fitted to both rear wheels. When fitting, comply with the manufacturer's instructions. When snow chains are in use, do not exceed 50 km/h (approx. 30 mph).



If the car has 17 or 18-inch wheels, snow chains cannot be fitted. ◀

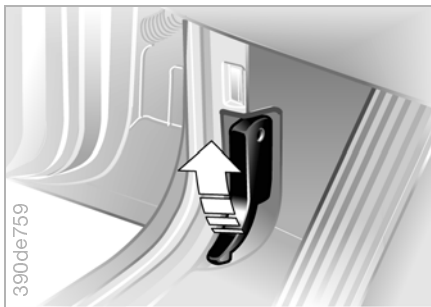

To unlock

Pull the lever at the left under the instrument panel.

 Do not work on the car unless you possess the appropriate specialised knowledge. If unfamiliar with the regulations which have to be complied with, have the work performed by BMW Service; incorrect handling of parts and materials could represent a safety risk for the car's occupants or other road users. ◀



To open

Pull the release lever and open the lid.

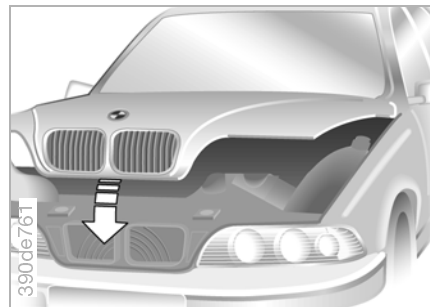

To close

Allow the engine compartment lid to drop from a height of approx. 30 cm (12 in) such that it is clearly heard to engage.

 To avoid injuries, as when closing all doors or lids on the car, make sure that the engine compartment lid is unobstructed.

If you notice during the journey that the engine compartment has not been properly closed, stop the car at the earliest possible moment and close it correctly. ◀

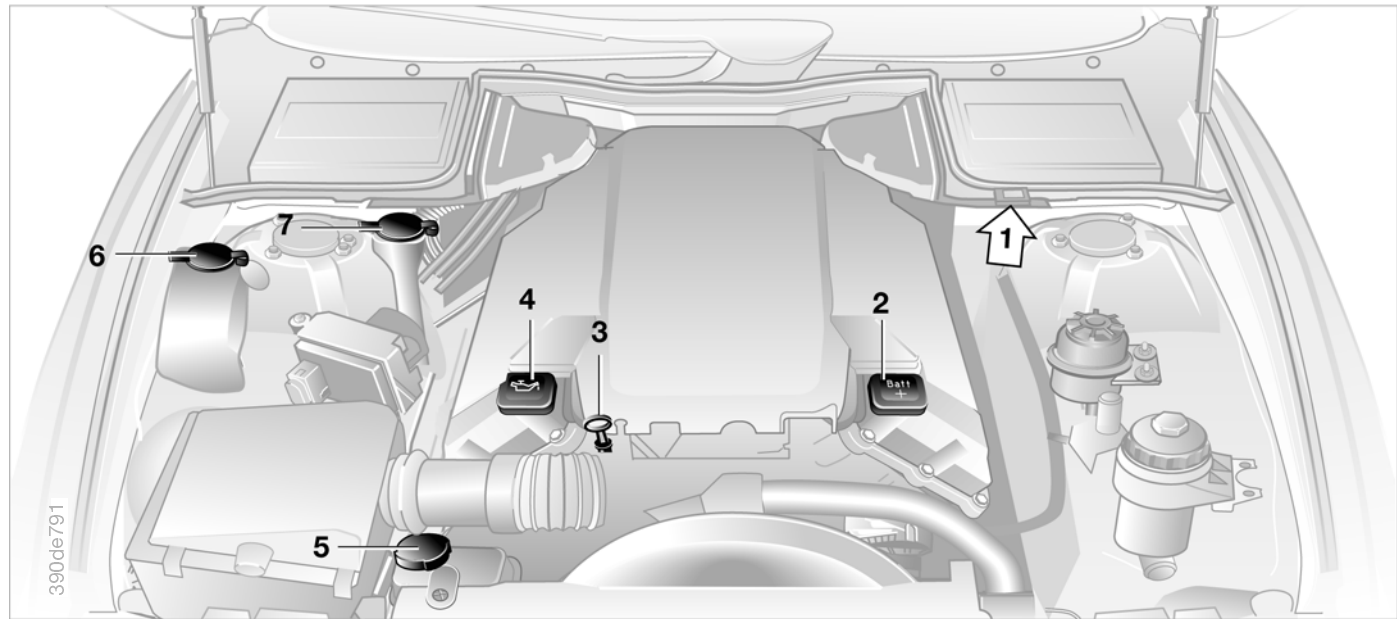

1 Reservoir for brake fluid (under the micro-filter housing) 154

2 Jump-start connection point 173

3 Engine oil dipstick 150

4 Engine oil filler cap 151

5 Coolant level-equalising tank 152

6 Reservoir for intensive cleaning system 150

7 Reservoir for windscreen washer and headlight cleaning system 150

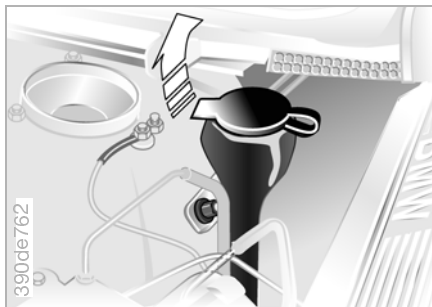

Headlight cleaning system* and windshield washer

Capacity in litres (Imp. pints).

Windscreen washer:

Approx. 3.5 (6.2) – saloon

Approx. 6.0 (10.6) – touring

Incl. headlight cleaning system:

Approx. 6.0 (10.6).

When filling with water and – when required – with screenwash, always follow the manufacturer's instructions.

 It is best to mix the water and additive before filling the washer fluid tank. ◀

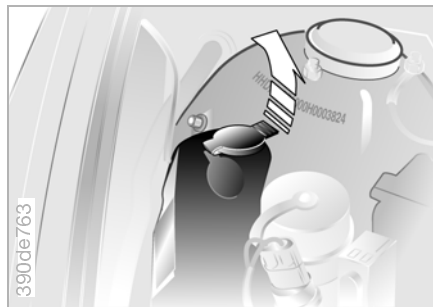

Intensive cleaning system*

Content approx. 1.0 litre (1.8 pints).

Fill with intensive cleaning agent. This is frost-resistant down to approx. -27°C and can be obtained from BMW Service.

 Screenwash for the cleaning or intensive cleaning systems is easily ignited. Keep it away from possible ignition sources and store it only in the carefully sealed original packs, out of reach of children. Comply with the instructions on the pack. ◀



Checking engine oil level

1. Park the car on a horizontal surface
2. Switch off the engine, which should be at its regular operating temperature
3. After about 5 minutes, take out the dipstick and wipe it clean with a lint-free cloth, paper tissue or similar
4. Carefully push the dipstick fully into its tube, then pull it out again
5. The oil level must be between the two marks on the dipstick.

Like fuel consumption, engine oil consumption depends on driving style and operating conditions.

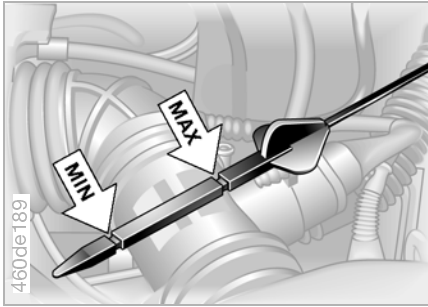

The quantity of oil between the two dipstick marks is approx. 1 litre (1.8 pints). Do not add oil above the upper dipstick mark. Adding too much oil will harm the engine.





Adding engine oil

Do not add more oil until the level has dropped almost as far as the lower dipstick mark.

 BMW engines are designed not to need separate additives in the engine oil, and indeed adding these substances could even be harmful in certain circumstances. This applies to manual-shift gearbox or automatic transmission, final drive and power steering. ◀

Recommendation: have oil changes carried out by BMW Service.

 In laboratory tests, prolonged contact with used oils has caused cancer. For this reason, always wash the affected skin areas thoroughly with soap and water after work. Keep oils, greases, etc. out of children's reach and in vessels marked with a suitable warning. ◀

 When disposing of used oil, comply with the relevant environmental protection laws. ◀

Specified engine oils

The quality of the engine oil is a decisive factor for the correct operation and long life of your car's engine. BMW has conducted extensive tests before approving certain grades of engine oil.

Petrol and diesel engines:

The highest quality standards are achieved by oils which BMW has approved as "long-life 01" oils.

Use only an approved grade of "long-life 01" oil.

If you are unable to purchase one of these oils, you can top up the oil level in between oil changes, if only a small amount of oil is needed, with a BMW-approved "long-life 98" grade of oil. Only if no such oil is available should you top up the engine oil level with an approved "special oil" or an oil to ACEA: A3 specification.

 BMW Service can provide details of the oils approved by BMW for your car's engine. ◀

Diesel engines:

The engine oil chosen must always comply with the ACEA: A3/B3 or ACEA: A3/B4 specification.

Approved "long-life 01" oils always meet this specification.

Viscosities

All "long-life" oils approved by BMW are suitable for operation at any ambient temperature. You consequently do not need to pay specific attention to the viscosity class.

Coolant

Do not top up the cooling system while the engine is hot, otherwise you may scald yourself on the resultant coolant steam.

To avoid the risk of subsequent damage, use only long-life antifreeze and corrosion inhibitor free from nitrites and amino compounds, and approved by the manufacturer. BMW Service is familiar with these products. Antifreeze and corrosion inhibitor constitutes a health hazard. Store it in sealed original packs, out of reach of children.

Long-life antifreeze and corrosion inhibitor contains ethylene glycol, which is flammable. For this reason, take care not to spill long-life antifreeze and corrosion inhibitor on hot parts of the engine; it could ignite and cause burns. ◀

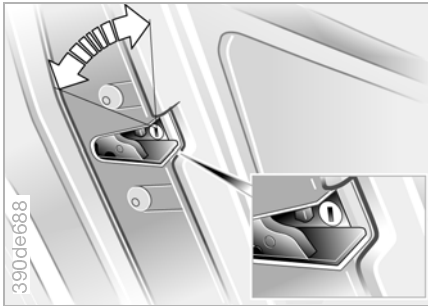

Checking coolant level and adding coolant

Diesel engine:

Correct coolant level with engine cold (approx. 20 °C):

Just below the KALT/COLD mark on the translucent reservoir.

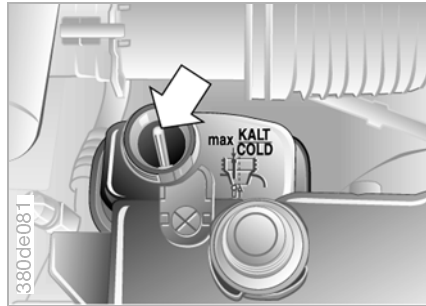

Spark-ignition engine:

Correct coolant level with engine cold (approx. 20 °C):

1. Turn the cap on the header tank slightly anti-clockwise until it starts to open, then allow the pressure to escape before opening it fully
2. Coolant level is correct when the top end of the red float rod is at least level with the top of the filler pipe (see arrow in picture), but not more than 2 cm (0.8 in) higher, in other words at the second mark on the float rod (see also diagram next to filler pipe).

3. If necessary, add more coolant. Slowly top up to correct level – do not overfill.



When disposing of used long-life antifreeze and corrosion inhibitor, comply with the relevant environmental protection laws. ◀

Indicator light

If the warning light comes on for brake hydraulics, or the message "Check brake fluid" appears in the Check Control: brake fluid level is too low.

Adding brake fluid

The brake fluid reservoir is located under the micro-filter housing on the driver's side. To top up the brake fluid, or to rectify the cause of any loss of brake fluid, please consult BMW Service which is familiar with the factory-approved grades of brake fluid (DOT 4).

Loss of brake fluid may cause brake pedal travel to increase. Comply with the instructions on page 144.



Brake fluid is hygroscopic, that is to say it absorbs moisture gradually from the air.

To ensure that the car's brake system remains in good working order, have the brake fluid renewed every two years by BMW Service, see also pages 80 and the Service Booklet. Brake fluid constitutes a health hazard and also attacks the car's paint. Store it in sealed original packs, out of reach of children. Do not spill brake fluid; add it only up to the MAX mark on the reservoir. If it comes into contact with hot parts of the engine, brake fluid may ignite and cause burns. ◀



When disposing of brake fluid, always comply with the appropriate environmental legislation. ◀



The BMW Maintenance System is designed to uphold the car's road safety and operating reliability – and to save the customer as much money as possible.

Please remember that regular maintenance is not only essential to ensure that your car remains safe, but also to enhance its resale value.

Service Interval indicator

Whereas conventional systems call for maintenance when a fixed distance in kilometres/miles has been covered, the BMW Maintenance System has for many years now taken the car's operating conditions into account as well, since one kilometre is by no means the same as another.

100,000 kilometres completed exclusively in the form of short journeys cannot be equated the same distance made up of long main-road journeys only.

The maintenance routines based on actual use of the car consist of the Oil Service and Inspections I and II.

The principle of determining maintenance intervals according to load effectively covers all the operating conditions to which the car is likely to be exposed. Drivers who cover only very short annual distances – well below 10,000 km (approx. 6,000 miles) – should none the less have an engine oil change carried out every two years, since engine oil ages regardless of the loads imposed on it.

Service Booklet

For further information on maintenance points and the scope of maintenance work, please refer to the car's Service Booklet.

Depending on the circumstances in which the car is used, it may be worthwhile to inspect it for damage caused by stones flung up from the road, in order to guard against subsequent corrosion.

 Have maintenance and repair work carried out by BMW Service. Make sure that maintenance work is confirmed in the Service Booklet after it has been carried out. These entries are evidence that your car has been serviced regularly and correctly, and are also the basis of any warranty claims.<

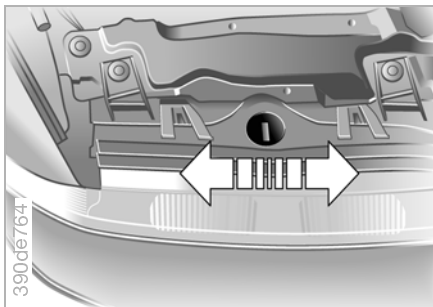

When entering another country involves a switch to driving on the other side of the road:

1. Remove the plugs above the headlights
2. For driving on the left: slide lever towards centre of car
For driving on the right: slide lever towards outside of car.

Technical modifications

Light-emitting diodes (LED)

Controls, displays and other equipment items inside your car have light-emitting diodes (LEDs) behind a cover as their light source. These LEDs resemble conventional lasers and are classified by law as Class 1 light-emitting diodes.



Do not remove the cover or expose the eyes directly to the unfiltered light source for several hours at a time, as this could cause irritation to the iris. ◀

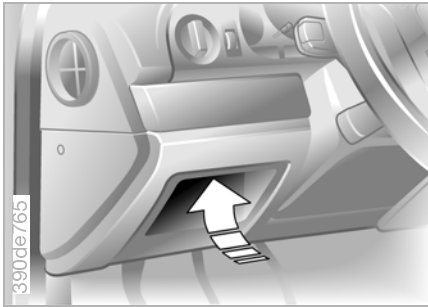

Access to socket for On-Board
Diagnosis (OBD):
Lift the cover on the top of the compart-
ment next to the steering column
(arrow).

Components which have a decisive
effect on exhaust emissions can be
tested at this interface with a suitable
device.

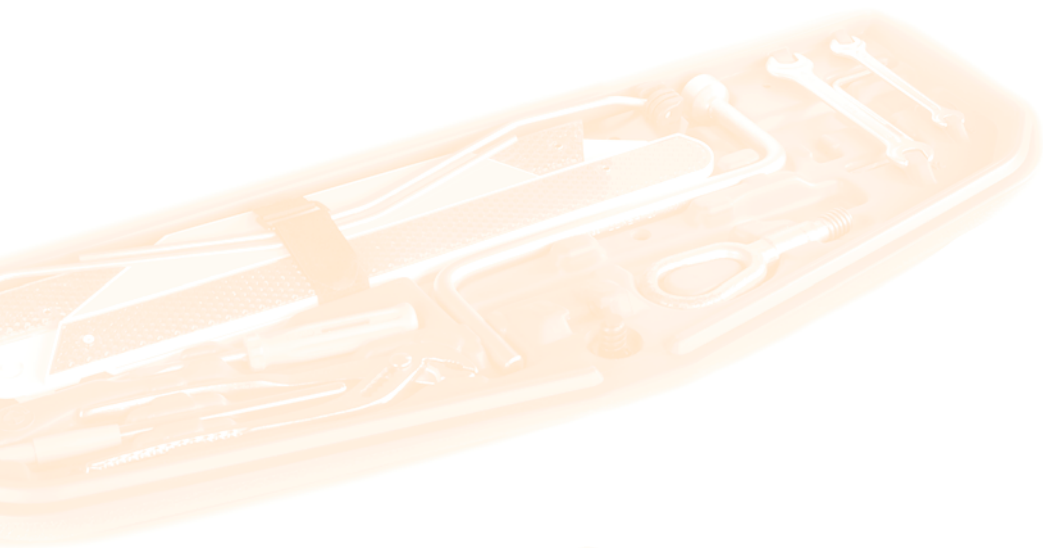

Initial overview

Controls in detail

Operation, maintenance

Minor repairs

Technical data

Index

Overview

Controls

Maintenance

Minor repairs

Data

Keywords



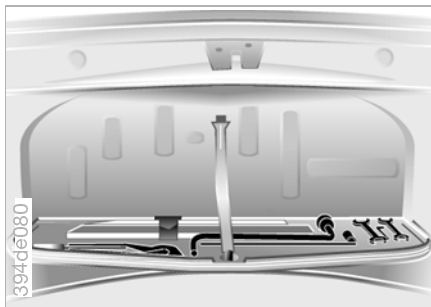

The toolkit is located in the luggage compartment lid/tailgate.

To open, undo the wing bolt(s).

Wiper blades

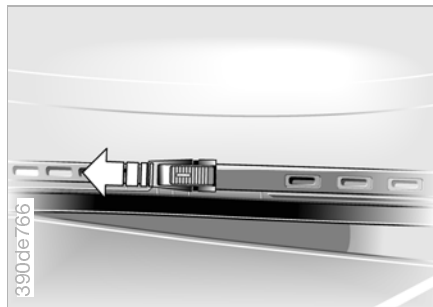

Front

1. Raise the wiper arm slightly and hold it firmly
2. Move the sliding safety catch (arrow) and take off the wiper blade towards the windscreen
3. Attach the new wiper blade and slide the safety catch back.

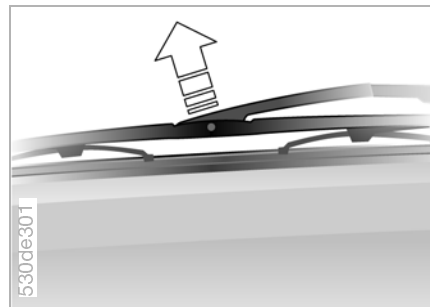

Rear*

1. Hold the wiper blade against the glass and pull the wiper arm off/unclip it (arrow) at the outer pivot
2. Offer up the new wiper blade and press it against the wiper arm (clip into position).

 Use only BMW-approved wiper blades. ◀

Lights and bulbs

Lights and bulbs make an important contribution towards road safety. Appropriate care and attention should therefore be taken when handling these components. If you are unfamiliar with such tasks, it is better to entrust them to BMW Service.

Do not touch the glass of a new bulb with the fingers, because even slight amounts of dirt or grease will then be burned into the bulb and reduce its working life. Use a clean tissue, cloth or similar, or hold the bulb by its base. ◀

A box containing spare bulbs is available from BMW Service.

! Before any work is done on the electrical system, switch off the affected consumer equipment or disconnect the negative terminal from the battery, to prevent any risk of short-circuits occurring. Observe any instructions supplied by the bulb manufacturer, to avoid causing injury or damage when changing bulbs. ◀

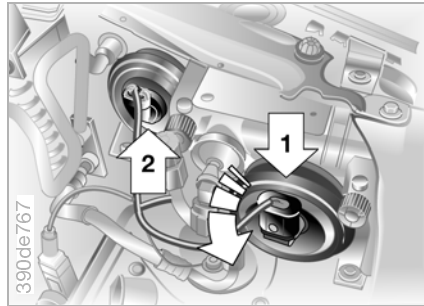

Right-hand side of engine compartment.

- 1 Low-beam headlights
- 2 High-beam headlights

Low-beam and high-beam headlights

H7 bulb, 55 Watt

! The bulb is pressurised, so protect the eyes and wear gloves. There is otherwise a risk of injury if the bulbs are damaged. ◀

1. Turn the bulb holder to the left (arrow) and take it off
2. Pull out the bulb and change it.

- ▶ Please note when cleaning the headlights:
- ▶ Do not rub them when dry or use caustic or abrasive cleaning agents
 - ▶ Soak dirt or other deposits (e.g. dead insects) with BMW Shampoo and wash down with plenty of water
 - ▶ Use a de-icer spray to remove ice deposits – not a scraper or other hard tool. ◀

Xenon headlights*

The operating life of these light units is extremely long and the likelihood of failure very low, provided that they are not switched on and off a very great number of times. If a xenon headlight should none the less fail, switch on the fog lights and continue the journey with great care, provided that local legislation does not prohibit this.

 In view of the risk of potentially fatal accidents resulting from the high electrical voltages that are present, work on the xenon lighting system including bulb changing should only be performed by specialist personnel. ◀

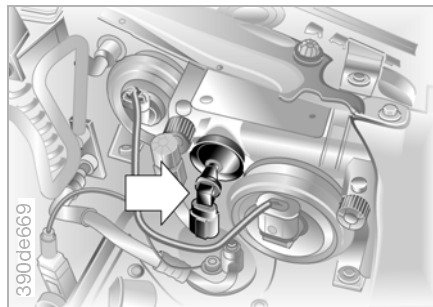
**Side and parking lights**

10 Watt bulb

 The bulb holder and reflector are a single unit, and are changed together. ◀

1. Turn the bulb holder with reflector to the left and take it out
2. Detach the cable connector
3. Attach new bulb holder to plug connector – making sure that it engages correctly
4. Insert reflector with bulb holder and twist clockwise as far as limit position.

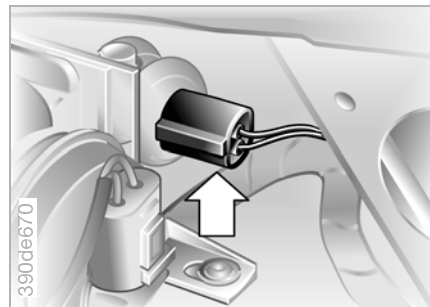
**Front flashing turn indicator**

21 Watt bulb

1. Turn the bulb holder to the left and take it off
2. Press the bulb in slightly, turn to the left and remove.

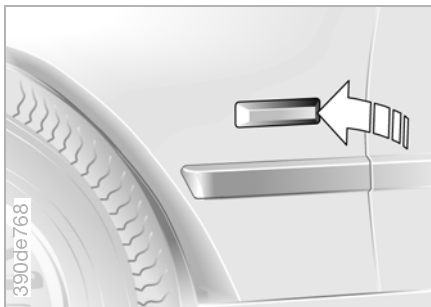

Side turn indicator repeater*

5 Watt bulb

1. Press the light forwards at its rear edge (arrow) with the fingertip and take it out
2. Press the bulb in slightly, turn to the left and remove.

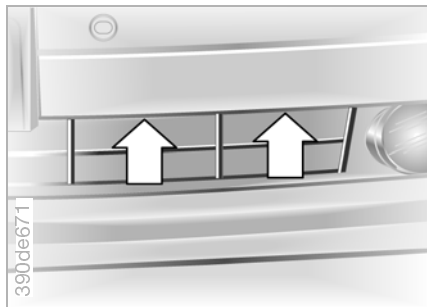

Fog lights

H8 bulb, 35 Watt

 The bulb is pressurised, so protect the eyes and wear gloves. There is otherwise a risk of injury if the bulbs are damaged. ◀

1. Remove the retaining clips on the air inlet grille (arrows) with the aid of a screwdriver, and take off the grille to the front

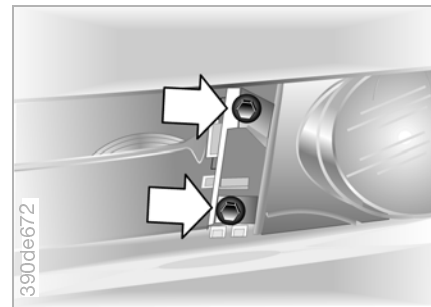

2. Remove the two screws (arrows)
3. Remove the cover next to the headlight
4. Rotate the headlight through 90° anti-clockwise and pull forward to remove
5. Detach the cable connector
6. Turn the bulb anti-clockwise and remove.

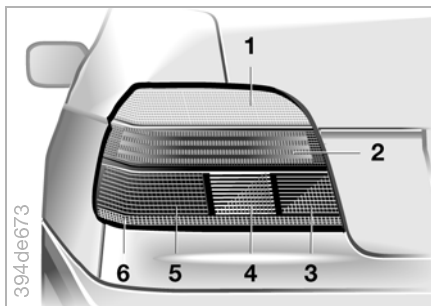

Rear lights – saloon

Rear lights: light-emitting diodes
Other lights: 21 Watt

- | | |
|----------------------------|-------|
| 1 Flashing turn indicators | white |
| 2 Rear lights | red |
| 3 Rear fog lights | red |
| 4 Reversing lights | white |
| 5 Brake lights | red |
| 6 Reflectors | red |

 In the event of a fault in the rear lights, have it rectified by BMW Service. ◀

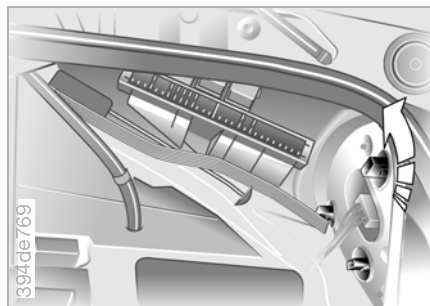

1. Fold down the side trim in the luggage compartment, using the handle at the top
2. Turn the affected bulb holder to the left (arrow) and remove it
3. Press the blown bulb in slightly and turn to the left, take out and renew
4. Insert bulb holder and twist clockwise as far as limit position.

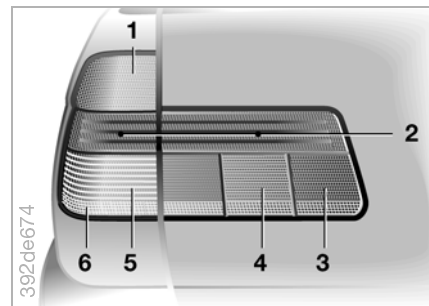

Rear lights – touring

Rear lights: light-emitting diodes
Other lights: 21 Watt

- | | |
|----------------------------|-------|
| 1 Flashing turn indicators | white |
| 2 Rear lights | red |
| 3 Rear fog lights | red |
| 4 Reversing lights | white |
| 5 Brake lights | red |
| 6 Reflectors | red |

 In the event of a fault in the rear lights, have it rectified by BMW Service. ◀

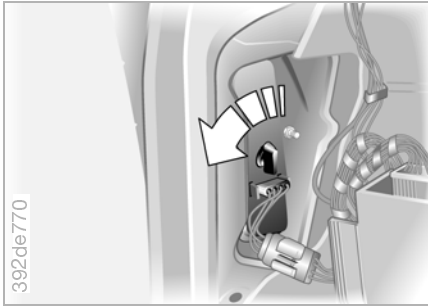

Lights in rear panel:

1. Open the flap in the side panel trim
2. Turn the quick-release fastener and take off the trim in front of the bulb holder
3. Turn the quick-release fastener (arrow) and take off the bulb holder
4. Press the bulb in slightly, turn to the left and remove.

If a sub-woofer loudspeaker* is installed behind the right-hand flap, release the toggle screw and swing the sub-woofer to one side.

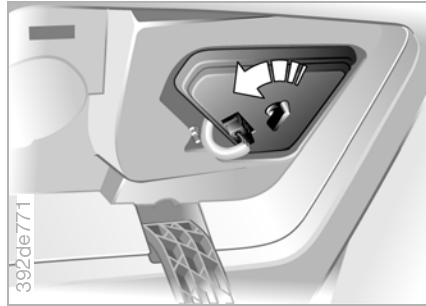

Lights in tailgate:

1. Open the trim in the tailgate
2. Turn the quick-release fastener (arrow) and take off the bulb holder
3. Press the bulb in slightly, turn to the left and remove.

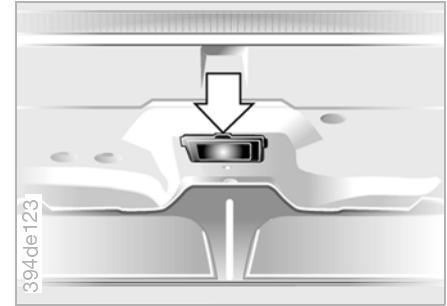

Central brake light*

21 Watt bulb

1. Open the luggage compartment lid
2. Use a screwdriver to unclip the cover on the underside of the rear window shelf (arrow)
3. Turn the bulb holder to the left and take it off
4. Press the bulb in slightly, turn to the left and remove.

touring: LED strip light in tailgate.

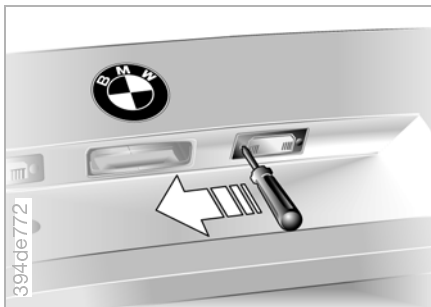

Licence plate lights

5 Watt bulb

1. Insert screwdriver into slot and press to the left (arrow); this will release the light
2. Take out the light and change the bulb.

Remote control for auxiliary heater

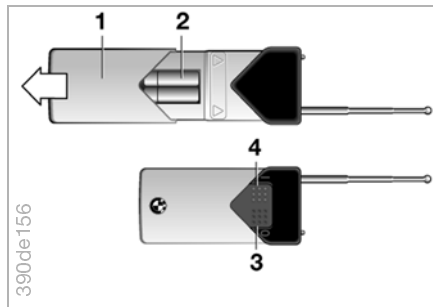

New transmitter

If you begin to use a new transmitter (either a replacement or an additional transmitter), it must first be initialised. Either one or two transmitters can be used.



Observe the times stated below accurately, otherwise initialising will fail and have to be repeated. ◀

Changing the batteries

Renew the batteries if the indicator light no longer flashes when the auxiliary heater is switched on.

1. Pull open cover 1 for battery compartment
2. Insert two batteries 2 of the same type (LR 1). Battery type and installed position are marked on the base of the battery compartment
3. Press the cover back into position.



Dispose of old batteries only at an authorised collecting point or return them to BMW Service. ◀

1. Remove the fuse for the auxiliary heater (in luggage compartment or load area on right, see page 172) and insert it again after 10 seconds
2. Within 3 seconds of having inserted the fuse again, press button 3
3. Next, press button 4 within 5 seconds
4. After a further 3 seconds, the system is operational.

Wheel-changing



Safety precautions in the event of a puncture or tyre failure:

Halt the car as far away from the main traffic flow as possible, on a firm surface; switch on the hazard warning flashers.

Engage the steering lock in the straight-ahead position, apply the handbrake and select first or reverse gear or selector lever position P.

All occupants must leave the car and be led to a point where they are not exposed to risk, for example behind a crash barrier at the side of the road.

If necessary, set up the warning triangle or a flashing warning light at a sufficient distance to the rear. Comply with relevant local laws.

Only change wheels on a flat, firm and non-slip surface. On a soft or low-grip surface (snow, ice, tiles or similar) there is a risk of the car or the jack sliding sideways.

Position the car's jack on a firm surface. Never place wood blocks or similar under the jack, or the maximum lifting capacity may be exceeded. When the car has been jacked up, do not lie under it or start the engine, as this could lead to a potentially fatal accident. ◀

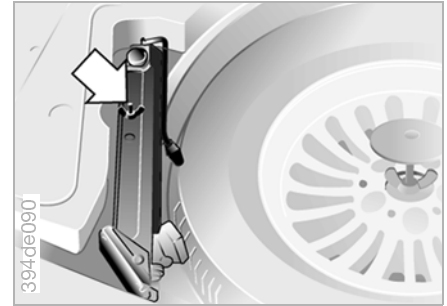

What you need

To avoid rattling noises later, please make a note of the positions of the tools when they are removed, and replace them in the same positions later.

▷ Jack

Saloon: fold back the floor mat in the luggage compartment and loosen the wing nut (arrow).

touring: raise the floor panel and the spare wheel cover (see page 134).

After using the jack, retract it fully, swing the crank handle back in and clip it securely

▷ Wheel chock

Next to the jack. Unscrew the wing nut to remove it.



- ▷ Spare wheel and adapter* to remove the wheel stud cover* (see next but one column)

Both are kept next to the jack. Take off the adapter or the plastic cap. Unscrew the wing nut (arrow) by hand and take out the wheel

- ▷ Wheel stud wrench and screwdriver
In the toolkit in the luggage compartment lid/tailgate (see page 160), touring: the wheel stud wrench is next to the spare wheel.

Procedure

1. Note the safety precautions on the previous page
2. Prevent the car from rolling away: Place the wheel chock behind the front wheel on the side opposite to where the wheel is to be removed (or in front of the front wheel on a downhill gradient). If the car cannot be moved to a point on a less severe gradient, you must protect it reliably against rolling away
3. If full-width wheel covers* are installed: reach into the vent holes and pull the cover off



4. Version with adapter*: place the adapter on the wheel stud cover, attach the wheel stud wrench and press to the left (see illustration)
5. If hub covers* are fitted: lever off the cover by inserting a screwdriver blade into the slot. For theftproof wheel studs, see page 170
6. Slacken off the wheel studs by a 1/2 turn

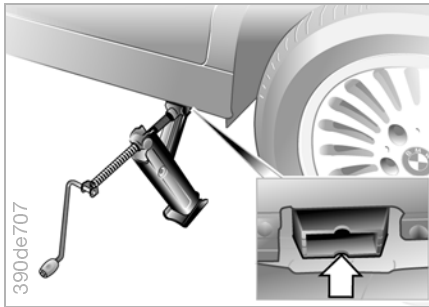

7. Attach the jack to the nearest mounting point to the wheel which is to be removed; the full surface area of the base of the jack should make contact with the ground, and the jack head should enter the rectangular recess of the mounting point (see picture detail) as the jack is raised
8. Continue to turn the crank handle until the wheel you wish to change is lifted clear of the ground
9. Take out the wheel studs and remove the wheel
10. Remove heavy dirt deposits from the wheel and hub contact faces and clean the wheel studs



11. Offer up the new wheel and secure it with at least two studs inserted on opposite sides of the hub
12. Insert and screw up the remaining wheel studs, then tighten them all firmly, working across the hub rather than round it
13. Lower the car and remove the jack
14. Tighten the studs alternately on opposite sides of the hub
15. With full-width wheel covers: place the cover in position so that the valve cutout is aligned with the tyre valve, then press the cover on to the wheel with both hands

▶ For this lightweight wheel, use only the special full-width cover supplied with the car, otherwise the cover may not be held firmly. ◀

16. With hub cap: offer up the cap and press into position
17. With wheel stud cover: align the arrow on the cover with the line on the wheel, then press the cover on
18. Correct the tyre pressure at the earliest opportunity.
Cars with Tyre Pressure Control (RDC)*:
After fitting the spare wheel or correcting the tyre pressure, re-activate the system, see page 105.

! Use the jack only for wheel-changing. Do not attempt to raise another type of vehicle or any other load with this jack; this could result in injury or damage.

For safety reasons, have the wheel stud tightening torque checked without delay, using a suitable calibrated torque wrench (correct tightening torque = 100 Nm). ◀

When replacing a wheel in the spare wheel well, make sure that the central threaded rod in the well is not bent or damaged.

If the car is not fitted with alloy wheels of the Original BMW type, note that different wheel studs may be needed.

Have a flat tyre repaired as soon as possible, and the wheel and tyre rebalanced before fitting.

Fit dust caps on tyre valves, to keep dirt out. Dirt in the tyre valve can often lead to a gradual loss of air pressure.

▶ For the lightweight wheel, use only BMW-approved balance weights for alloy wheels. Do not attempt to use hammer-on steel balance weights on these wheels. ◀

▶ With certain tyre sizes, in the event of a puncture or similar it may be necessary to fit the spare wheel and tyre (of a different size). Although this wheel can be used entirely satisfactorily in all load and speed ranges, in such cases, fit a wheel and tyre of the correct size as soon as possible. ◀

Thiefproof wheel studs*

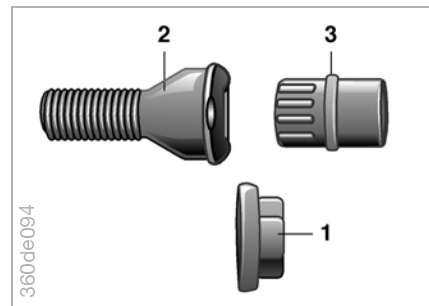

- 1 Stud cap (not for wheels with wheel stud cover or hub cap)
- 2 Wheel stud for adapter
- 3 Adapter (in toolkit, next to spare wheel in the touring)

To remove:

1. Turn cap 1 slightly to the left with the wheel stud wrench, and take it off
2. Take adapter 3 out of the toolkit and insert it into the wheel stud
3. Unscrew wheel stud 2.

After inserting and tightening the wheel stud again, remove the adapter and press on the stud cap.

 The cap is located correctly if the M of the BMW badge is over a raised section on the wheel stud when pressed on. ◀

The code number is embossed on the front of the adapter. Please make a careful note of this number and keep it in a safe place, in case the adapter is lost.

Maintenance

The battery needs no routine maintenance whatsoever, in other words the quantity of acid it contains will normally last for the full operating life of the battery in temperate climates.

 Please address all queries concerning the battery to BMW Service. As the battery is absolutely maintenance-free, the following information is provided for reference only. ◀

 Do not disconnect battery leads while the engine is running, otherwise excess current will destroy the vehicle electronics unit. ◀

Recharging the battery

Recharge the battery only with the engine stopped, via the connections in the engine compartment (see "Starting with a flat battery", page 173).

 Dispose of old batteries only at an authorised collecting point or return them to BMW Service. Batteries filled with acid should be transported and stored upright. Protect batteries against falling over when in transit. ◀

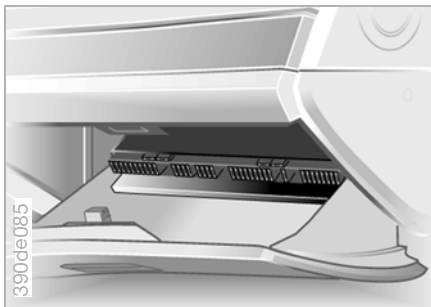

In glove box

Open the glove box and turn the two white quick-release fasteners to the left.

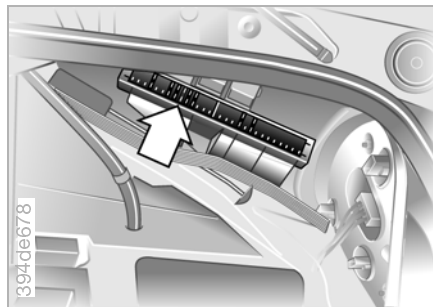

In the luggage compartment

Fold the right-hand side trim down with the handle provided.

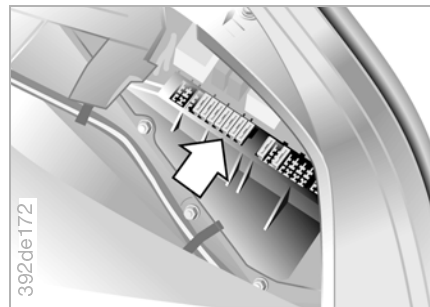

In the load area

Press the button on the right-hand flap to open it, and pull the trim to one side.

If a sub-woofer loudspeaker* is installed behind the right-hand flap, release the toggle screw and swing the sub-woofer to the side.



Do not repair blown fuses or replace them with fuses with different colours or ampere ratings, otherwise overloaded electrical wires can cause a fire in the vehicle. ◀

The Mobile Service of the BMW Group is there to assist you round the clock, including at weekends and on public holidays.

If you have a breakdown, please call the Mobile Service control centre for your home country. The telephone numbers are to be found in the "Service Contact" brochure.

Do not use the spray products sold as starting aids.

If the car's own battery is flat, your BMW's engine can be started by using two jump leads from another vehicle's battery. In the same way, you can help another car to start. Use only leads with fully insulated battery post clips.



Do not touch any electrically live parts when the engine is running, or a fatal accident may occur. Do not depart from the procedure described below, otherwise personal injury could result or one or both vehicles be damaged. ◀

1. Check that the other vehicle's battery has a voltage of 12 Volt. This should be printed on the battery cover
2. Do not disconnect the batteries when jump-starting. Switch off any consumers in both vehicles
3. The bodies of the two vehicles must not make contact – risk of short-circuit
4. Run the engine of the donor vehicle

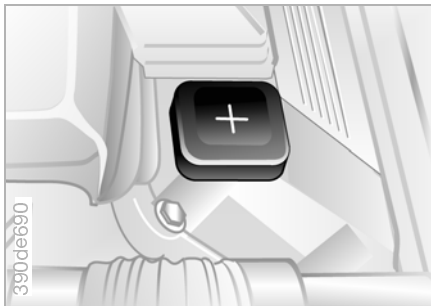

5. With the jump lead marked (+), establish a connection between the positive terminal of the battery in the other vehicle and the jump-starting connection in the engine compartment of the BMW. The cap over this connection on the BMW is marked "+" (see illustration). Fold open the cap (arrow)

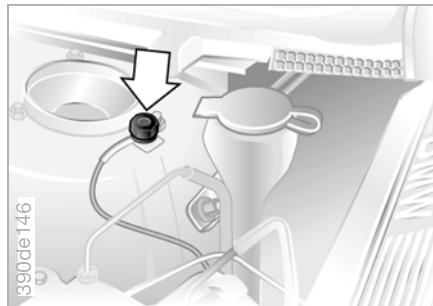

6. With the jump lead marked (-), establish a connection between the negative terminals of the two vehicles. First connect it to the negative battery terminal or to earth (ground) on the engine or body of the donor vehicle, then to the negative battery terminal or to earth (ground) on the engine or body of the vehicle which you wish to start. On your BMW a special nut is provided for this purpose on the suspension strut housing; see arrow in illustration



Always connect the jump leads in the correct order, so that no sparks which could cause injury occur at the battery. ◀

7. Run the engine of the donor vehicle at higher than idle speed for a few minutes, then start the engine of the other vehicle in the usual way. If an initial attempt to start the engine fails, wait several minutes until the flat battery has been recharged to a slightly greater degree
8. Allow both engines to run for a few minutes before disconnecting the jump leads
9. Disconnect the jump leads in the opposite order from that in which they were originally attached.

Have the battery recharged by BMW Service if necessary.

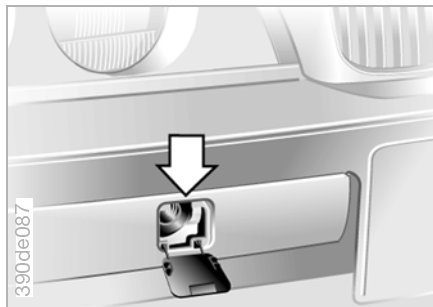

Towing eye

The screw-in towing eye is kept in the car's toolkit (on the touring, next to the spare wheel) and should always be carried on the car. It can be screwed in at the front or the rear of the car, and is only to be used for towing on a firm road surface.

Access to threaded hole

Front:

Press the arrow symbol on the cover and swing it out to remove.

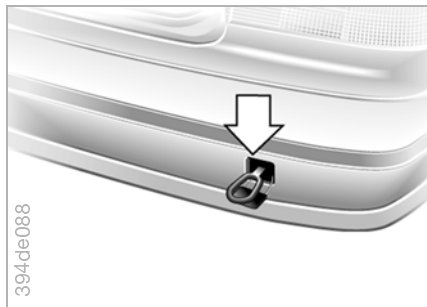

Rear:

Press the arrow symbol on the cover and swing it out to remove.

 Screw the towing eye in fully to avoid the risk of its thread being damaged.

Never tow the car or lash it down at any of the suspension elements, as this could cause damage and lead to accidents occurring later. ◀

For towing, use either a towbar or a nylon rope or tapes; use of the latter helps to avoid sudden tensile loads.

 Avoid offset between the towing and towed vehicle, and make sure that the towrope is taut when the towing vehicle moves off. ◀

Using a towbar

The towing eyes of both vehicles should be on the same side. If it is impossible to avoid attaching the towbar at an angle, note the following:

- ▷ Towbar clearance may be restricted when cornering
- ▷ The towbar will generate lateral forces if it is attached offset.

 Do not tow a vehicle heavier than your own, as there is otherwise a risk of losing control. ◀

Tow-starting

Cars with catalytic converter should only be tow-started if the engine is cold. It is always preferable to use jump leads, see page 173.

1. Switch on the hazard warning flashers (comply with local regulations)
2. Turn the ignition key to position 2
3. Select 3rd gear
4. Keep the clutch pedal down. When the car is moving, gradually release the clutch pedal. After the engine has fired and is running, depress the clutch pedal again
5. Switch off the hazard warning flashers.

Have the cause of starting problems traced and rectified by BMW Service.

Automatic-transmission cars:

These cars cannot be tow-started.

Starting with jump leads: see page 173.

Towing away

1. Turn ignition key to position 1, to enable the brake lights, turn indicators, horn and windscreen wipers to be activated
2. Switch on the hazard warning flashers (comply with local regulations)

If the car's electrical system has failed, the car must be made identifiable to following vehicles, for instance by placing a notice or the warning triangle in the rear window.



Make sure that the ignition key is turned to position 1 even if the electrical system has failed; this is to ensure that the steering lock cannot engage and prevent the car from being steered.

When the engine is not running, there is no power assistance and the brake servo is out of action. The steering and brakes will require extra effort to operate. ◀

Automatic-transmission cars:

1. Set the selector lever to N
2. Maximum towing speed:
70 km/h (approx. 43 mph)
3. Maximum towing distance:
150 km (approx. 93 miles).

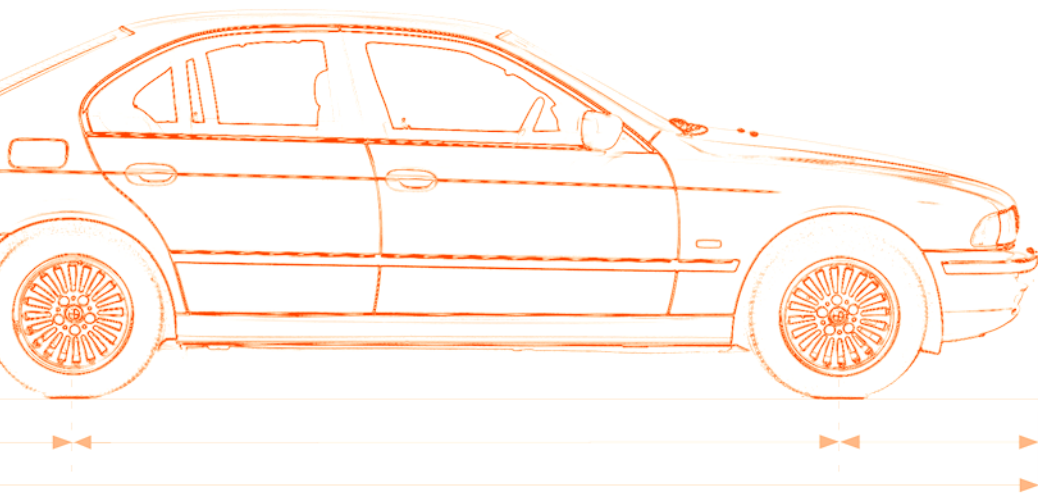

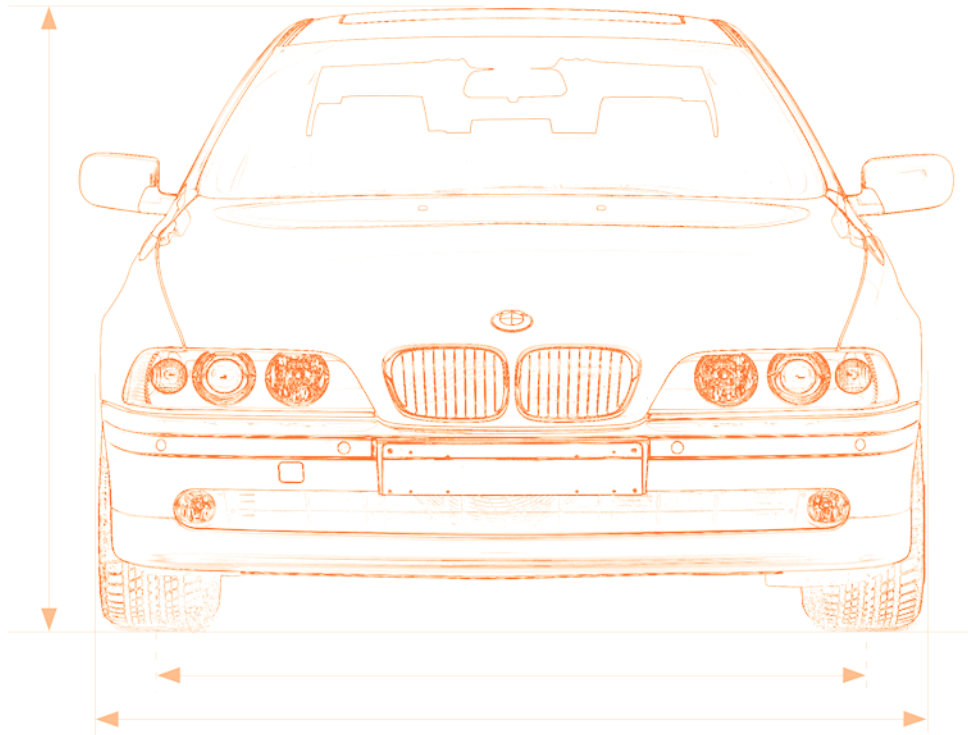

Initial overview

Controls in detail

Operation, maintenance

Minor repairs

Technical data

Index

Overview

Controls

Maintenance

Minor repairs

Data

Keywords

180 **Engine data**

		BMW 520i/ touring	BMW 523i	BMW 525i/ touring	BMW 530i/ touring	BMW 535i
Displacement	cc	2171	2394	2494	2979	3498
Number of cylinders		6	6	6	6	8
Max. power output at engine speed	kW/bhp rpm	125/170 6250	135/184 5800	141/192 6000	170/231 5900	180/245 5800
Max. torque at engine speed	Nm rpm	210 3500	240 3600	245 3500	300 3500	345 3800
Compression ratio	ε	10.7	10.5	10.5	10.2	10.0
Stroke	mm	72.0	72.0	75.0	89.6	78.9
Bore	mm	80.0	84.0	84.0	84.0	84.0
Mixture preparation	Digital Motor Electronics					

		BMW 540i/ touring	BMW 520d/ touring	BMW 525d/ touring	BMW 530d/ touring
Displacement	cc	4398	1951	2497	2926
Number of cylinders		8	4	6	6
Max. power output at engine speed	kW/bhp rpm	210/286 5400	100/136 4000	120/163 4000	142/194 4000
Max. torque at engine speed	Nm rpm	440 3600	280 1750	350 2000 to 2500	410 1750 to 3000
Compression ratio	ε	10.0	19.0	17.5	18.0
Stroke	mm	82.7	88.0	82.8	88.0
Bore	mm	92.0	84.0	80.0	84.0
Mixture preparation	Digital Motor Electronics	Digital Diesel Electronics (DDE)			

Fuel consumption, carbon dioxide/CO₂ emissions

		BMW 520i	BMW 520i	BMW 523i	BMW 525i
Urban	litres/100 km	5-sp. gearbox 12.2/12.8	Automatic 13.5/13.7	Automatic 15.8	5-sp. gearbox 13.1/13.4
	(Imp. mpg)	(23.1/22.1)	(20.9/20.6)	(17.9)	(21.6/21.1)
Extra-urban	litres/100 km	7.1/7.5	7.8/7.9	7.8	7.2/7.7
	(Imp. mpg)	(39.8/37.7)	(36.2/35.7)	(36.2)	(39.2/36.7)
Combined	litres/100 km	9.0/9.5	9.9/10.1	10.8	9.4/9.8
	(Imp. mpg)	(31.4/29.7)	(28.5/28.0)	(26.2)	(30.1/28.8)
CO ₂ emissions	grammes/km	216/228	237/242	247	225/235

		BMW 525i	BMW 530i	BMW 530i	BMW 535i
Urban	litres/100 km	Automatic 14.4/14.7	5-sp. gearbox 13.1/13.7	Automatic 15.5/15.7	5-sp. gearbox 17.5
	(Imp. mpg)	(19.6/19.2)	(21.6/20.6)	(18.2/18.0)	(16.1)
Extra-urban	litres/100 km	7.9/8.0	7.4/7.7	7.9/8.1	8.5
	(Imp. mpg)	(36.2/35.3)	(38.2/36.7)	(35.7/34.9)	(33.2)
Combined	litres/100 km	10.3/10.5	9.5/9.9	10.7/10.9	11.8
	(Imp. mpg)	(27.4/26.9)	(29.7/28.5)	(26.4/25.9)	(23.9)
CO ₂ emissions	grammes/km	247/252	229/238	257/261	283

		BMW 535i	BMW 540i	BMW 540i	BMW 520d
Urban	litres/100 km	Automatic 17.7	6-sp. gearbox 18.4/18.7	Automatic 18.2/18.9	5-sp. gearbox 7.8/8.1
	(Imp. mpg)	(15.9)	(15.3/15.1)	(15.5/14.9)	(36.2/34.9)
Extra-urban	litres/100 km	8.6	8.8/9.0	8.9/9.2	4.7/5.0
	(Imp. mpg)	(32.8)	(32.1/31.4)	(31.7/30.7)	(60.1/56.5)
Combined	litres/100 km	11.9	12.3/12.6	12.3/12.8	5.9/6.1
	(Imp. mpg)	(23.7)	(23.0/22.4)	(23.0/22.1)	(47.9/46.3)
CO ₂ emissions	grammes/km	286	295/302	295/307	156/163

First value: saloon; second value: touring

182 **Fuel consumption, carbon dioxide CO₂ emissios**

		BMW 525d	BMW 525d	BMW 530d	BMW 530d
		5-sp. gearbox	Automatic	5-sp. gearbox	Automatic
Urban	litres/100 km	9.2/9.5	11.1/11.5	9.7/9.6	11.8/11.6
	(Imp. mpg)	(30.7/29.7)	(25.4/24.6)	(29.1/29.4)	(23.9/24.3)
Extra-urban	litres/100 km	5.3/5.6	6.4/6.3	5.6/5.9	6.3/6.7
	(Imp. mpg)	(53.3/50.4)	(44.1/44.8)	(50.4/47.9)	(44.8/42.1)
Combined	litres/100 km	6.7/7.0	8.1/8.2	7.1/7.3	8.3/8.5
	(Imp. mpg)	(42.1/40.3)	(34.9/34.4)	(39.8/38.7)	(34.0/33.2)
CO ₂ emissions	grammes/km	179/187	216/219	189/194	221/226

First value: saloon; second value: touring

Fuel consumption is determined according to a standard test method (93/116/EU). It is not the same as the average fuel consumption in practice, which depends on a great many different factors such as driving style, load, road condition, traffic density and flow, weather, tyre pressures etc. Engine power output and road performance data are measured in the conditions laid down by 80/1269 EU and DIN 70020 (with the car to standard specification). This standard specifies the permitted tolerances. Additional equipment on the car may have quite a significant influence on both performance and fuel consumption, since it usually affects the car's weight and c_x value (drag coefficient), for instance roof rack, wider tyres, additional mirrors etc.

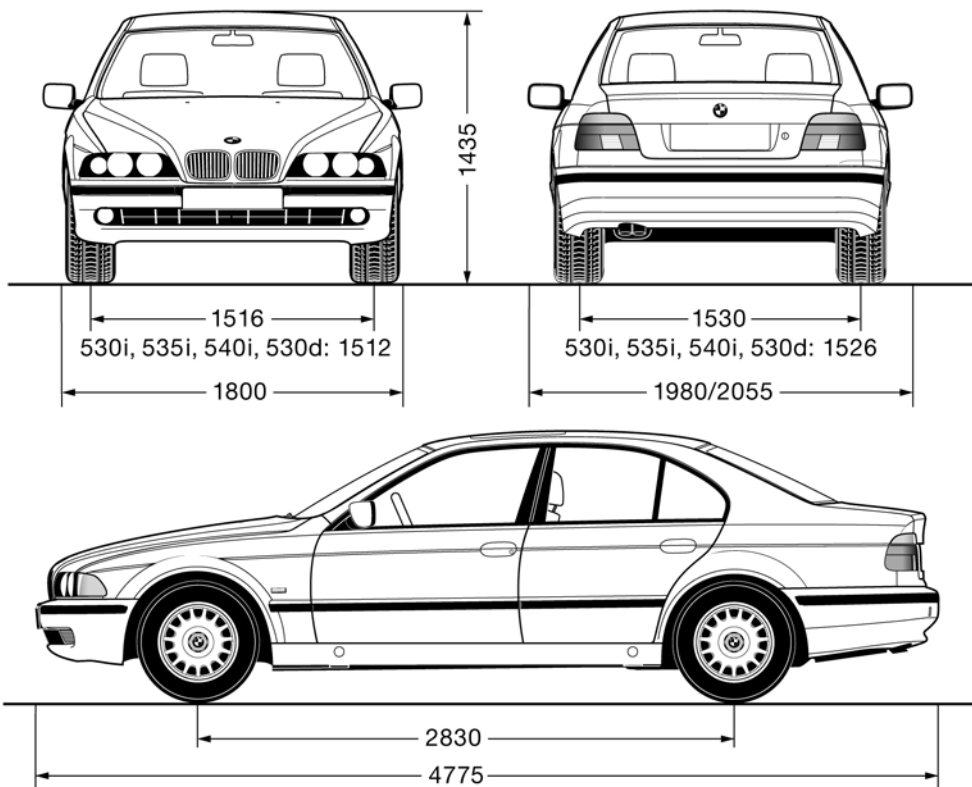

All dimensions in millimetres (mm). Value after /: with automatic-dip outside mirrors
 Minimum turning circle Ø: 11.3 m (37.1 ft); BMW 540i: 11.4 m (37.4 ft)

394de680

184 Dimensions

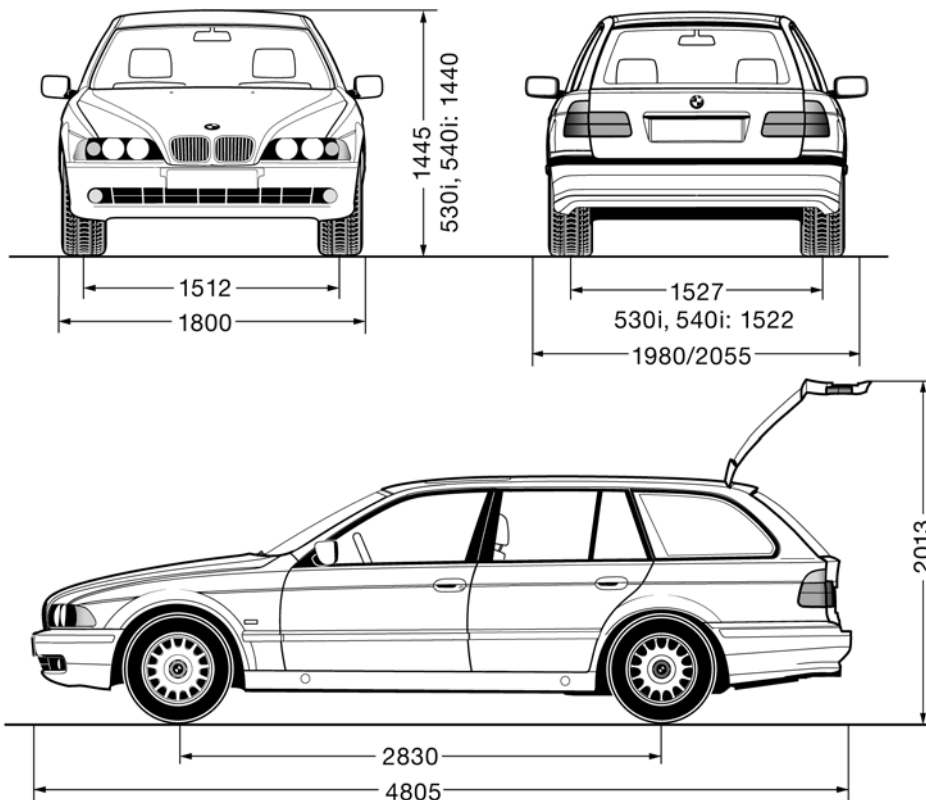

All dimensions in millimetres (mm). Value after /: with automatic-dip outside mirrors

Height with roof rails*: 1462 (BMW 530i, 540i: 1457)

Minimum turning circle Ø: 11.3 m (37.1 ft); BMW 540i: 11.4 m (37.4 ft)

		BMW 520i	BMW 523i/525i	BMW 530i	BMW 535i
Weight of car, unladen (with one occupant, ready for road, tank full, excluding optional extras)					
with manual gearbox	kg (lb)	1570 (2461)	1575 (2472)	1605 (3538)	1685 (3715)
with automatic transmission	kg (lb)	1600 (3527)	1605 (3538)	1635 (3605)	1730 (3814)
Permitted gross weight					
with manual gearbox	kg (lb)	2005 (4420)	2010 (4431)	2070 (4564)	2150 (4740)
with automatic transmission	kg (lb)	2035 (4486)	2040 (4497)	2100 (4630)	2195 (4839)
while towing a trailer					
with manual gearbox	kg (lb)	2095 (4618)	2030 (4475)	2050 (4519)	2240 (4938)
with automatic transmission	kg (lb)	2125 (4685)	2130 (4696)	2190 (4828)	2285 (5038)
Front axle load limit	kg (lb)	985 (2171)	985 (2171)	1020 (2249)	1090 (2403)
Rear axle load limit	kg (lb)	1125 (2480)	1125 (2480)	1170 (2579)	1200 (2645)
for trailer towing	kg (lb)	1240 (2734)	1240 (2734)	1275 (2811)	1305 (2877)
Towing loads according to EU operating permit (acc. to factory specification and legally permitted in Germany). BMW Service will have details of possible increases. Note and comply with different values in certain countries.					
unbraked	kg (lb)	750 (1653)	750 (1653)	750 (1653)	750 (1653)
braked, max. gradient 12% (with manual gearbox/automatic transmission)	kg (lb)	1500/1700 (3307/3748)	1800/1900 (3968/4189)	2000/2000 (4409/4409)	2000/2000 (4409/4409)
Trailer nose weight	kg (lb)			90 (198)	
Roof load	kg (lb)			100 (220)	
Luggage compartment capacity acc. to VDA test	litres (cu.ft)			460 (16.2)	

If you make full use of the quoted trailer load limit on gradients up to 12% and also wish to load the car itself up to its permissible gross weight limit, you are recommended not to drive up gradients steeper than 10%.

Do not exceed either the axle load limits or the car's gross weight limit.

186 **Weights – saloon**

		BMW 540i	BMW 520d	BMW 525d	BMW 530d
Weight of car, unladen (with one occupant, ready for road, tank full, excluding optional extras)					
with manual gearbox	kg (lb)	1705 (5759)	1565 (3450)	1670 (3682)	1700 (3748)
with automatic transmission	kg (lb)	1735 (3825)	–	1680 (3704)	1710 (3770)
Permitted gross weight					
with manual gearbox	kg (lb)	2170 (4784)	2000 (4409)	2135 (4707)	2165 (4773)
with automatic transmission	kg (lb)	2200 (4850)	–	2145 (4729)	2175 (4795)
while towing a trailer					
with manual gearbox	kg (lb)	2260 (4982)	2000 (4409)	2210 (4872)	2255 (4971)
with automatic transmission	kg (lb)	2290 (5049)	–	2235 (4927)	2265 (4993)
Front axle load limit	kg (lb)	1090 (2403)	975 (2149)	1060 (2337)	1080 (2381)
Rear axle load limit	kg (lb)	1200 (2646)	1135 (2502)	1170 (2579)	1170 (2579)
for trailer towing	kg (lb)	1305 (2877)	1200 (2646)	1275 (2811)	1275 (2811)
Towing loads according to EU operating permit (acc. to factory specification and legally permitted in Germany). BMW Service will have details of possible increases. Note and comply with different values in certain countries.					
unbraked	kg (lb)	750 (1653)	750 (1653)	750 (1653)	750 (1653)
braked, max. gradient 12 % (with manual gearbox/automatic transmission)	kg (lb)	2000/2000 (4409/4409)	1600/– (3527/–)	1800/2000 (3968/4409)	2000/2000 (4409/4409)
Trailer nose weight	kg (lb)			90 (198)	
Roof load	kg (lb)			100 (220)	
Luggage compartment capacity acc. to VDA test	litres (cu.ft)			460 (16.2)	

If you make full use of the quoted trailer load limit on gradients up to 12% and also wish to load the car itself up to its permissible gross weight limit, you are recommended not to drive up gradients steeper than 10%. Do not exceed either the axle load limits or the car's gross weight limit.

	BMW 520i	BMW 525i	BMW 530i	BMW 540i
Weight of car, unladen (with one occupant, ready for road, tank full, excluding optional extras)				
with manual gearbox	kg (lb) 1670 (3682)	1680 (3704)	1720 (3792)	1815 (3792)
with automatic transmission	kg (lb) 1700 (3748)	1710 (3770)	1750 (3858)	1845 (3858)
Permitted gross weight				
with manual gearbox	kg (lb) 2 195 (4839)	2205 (4861)	2245 (4949)	2280 (5026)
with automatic transmission	kg (lb) 2225 (4905)	2235 (4927)	2275 (5015)	2310 (5093)
while towing a trailer				
with manual gearbox	kg (lb) 2 125 (4685)	2205 (4861)	2270 (5004)	2370 (5225)
with automatic transmission	kg (lb) 2225 (4905)	2235 (4927)	2300 (5071)	2400 (5291)
Front axle load limit	kg (lb) 1000 (2205)	1000 (2205)	1025 (2260)	1095 (2414)
Rear axle load limit	kg (lb) 1275 (2811)	1275 (2811)	1275 (2811)	1275 (2811)
for trailer towing	kg (lb) 1360 (2998)	1360 (2998)	1400 (3086)	1410 (3108)
Towing loads according to EU operating permit (acc. to factory specification and legally permitted in Germany). BMW Service will have details of possible increases. Note and comply with different values in certain countries.				
unbraked	kg (lb) 750 (1653)	750 (1653)	750 (1653)	750 (1653)
braked, max. gradient 12% (with manual gearbox/automatic transmission)	kg (lb) 1600/1700 (3527/3748)	1800/1900 (3968/4189)	2000/2000 (4409/4409)	2000/2000 (4409/4409)
Trailer nose weight	kg (lb)		90 (198)	
Roof load	kg (lb)		100 (220)	
Luggage compartment capacity acc. to VDA test	litres (cu.ft)		410 – 1525 (14.5 – 53.8)	

If you make full use of the quoted trailer load limit on gradients up to 12% and also wish to load the car itself up to its permissible gross weight limit, you are recommended not to drive up gradients steeper than 10%.

Do not exceed either the axle load limits or the car's gross weight limit.

BMW 520i with manual gearbox: 1600 kg (3527 lb) trailer load only up to a gross vehicle weight of 2125 kg (4685 lb).
If the full gross vehicle weight of 2195 kg (4839 lb) is utilised, the max. towing load is only 1530 kg (3373 lb).

188 **Weights – touring**

		BMW 520d	BMW 525d	BMW 530d
Weight of car, unladen (with one occupant, ready for road, tank full, excluding optional extras)				
with manual gearbox	kg (lb)	1670 (3682)	1780 (3924)	1810 (3990)
with automatic transmission	kg (lb)	–	1790 (3946)	1820 (4012)
Permitted gross weight				
with manual gearbox	kg (lb)	2195 (4839)	2305 (5082)	2335 (5148)
with automatic transmission	kg (lb)	–	2315 (5104)	2345 (5170)
while towing a trailer				
with manual gearbox	kg (lb)	2110 (4652)	2210 (4652)	2360 (5203)
with automatic transmission	kg (lb)	–	2340 (5159)	2370 (5225)
Front axle load limit				
	kg (lb)	1000 (2205)	1065 (2348)	1085 (2392)
Rear axle load limit				
	kg (lb)	1290 (2844)	1310 (2888)	1310 (2888)
for trailer towing				
	kg (lb)	1300 (2866)	1390 (3064)	1390 (3064)
Towing loads according to EU operating permit (acc. to factory specification and legally permitted in Germany). BMW Service will have details of possible increases. Note and comply with different values in certain countries.				
unbraked	kg (lb)	750 (1653)	750 (1653)	750 (1653)
braked, max. gradient 12 %				
(with manual gearbox/automatic transmission)	kg (lb)	1600/– (3527/–)	1800/2000 (3968/4409)	2000/2000 (4409/4409)
Trailer nose weight				
	kg (lb)		90 (198)	
Roof load				
	kg (lb)		100 (220)	
Luggage compartment capacity acc. to VDA test				
	litres (cu.ft)		410 – 1525 (14.5 – 53.8)	

If you make full use of the quoted trailer load limit on gradients up to 12% and also wish to load the car itself up to its permissible gross weight limit, you are recommended not to drive up gradients steeper than 10%. Do not exceed either the axle load limits or the car's gross weight limit.

		BMW 520i	BMW 523i Automatic	BMW 525i	BMW 530i	BMW 535i
Top speed	km/h (mph)	226 (140)	225 (140)	238 (148)	250 (155)	250 (155)
with automatic transmission	km/h (mph)	220 (137)		232 (144)	244 (152)	247 (153)
Acceleration			9.3			
from 0 to 100 km/h (0 to 62 mph)	s	9.1 (10.2)		8.1 (8.9)	7.1 (7.6)	6.9 (7.6)
80 to 120 km/h (50 to 75 mph) in 4th gear	s	9.4	-	8.4	7.3	7.4

		BMW 540i	BMW 520d	BMW 525d	BMW 530d
Top speed	km/h (mph)	250 (155)	206 (128)	219 (136)	230 (143)
with automatic transmission	km/h (mph)	(governed) 250 (155) (governed)	-	219 (136)	230 (143)
Acceleration					
from 0 to 100 km/h (0 to 62 mph)	s	6.2 (6.5)	10.6	8.9 (9.1)	7.8 (8.0)
80 to 120 km/h (50 to 75 mph) in 4th gear	s	8.1 (in 5th gear)	9.3	7.8	6.9

Acceleration values in (): with automatic transmission

190 **Performance – touring**

		BMW 520i	BMW 525i	BMW 530i	BMW 540i
Top speed	km/h (mph)	223 (139)	235 (146)	250 (155)	250 (155)
with automatic transmission	km/h (mph)	217 (135)	229 (142)	241 (150)	(governed) 250 (155) (governed)
Acceleration					
from 0 to 100 km/h (0 to 62 mph)	s	9.5 (10.5)	8.5 (9.3)	7.5 (7.9)	6.3 (6.7)
80 to 120 km/h (50 to 75 mph) in 4th gear	s	9.9	8.9	7.7	8.6 (in 5th gear)

		BMW 520d	BMW 525d	BMW 530d
Top speed	km/h (mph)	204 (127)	215 (134)	227 (141)
with automatic transmission	km/h (mph)	–	215 (134)	227 (141)
Acceleration				
from 0 to 100 km/h (0 to 62 mph)	s	10.9	9.4 (9.6)	8.1 (8.3)
80 to 120 km/h (50 to 75 mph) in 4th gear	s	9.9	8.5	7.4

Acceleration values in (): with automatic transmission

	Litres (Imp. units)	Note
Fuel tank – including reserve of	approx. 70 (15.4 gal.) approx. 8 (1.8 gal.) – with 4- and 6-cylinder engine approx. 10 (2.2 gal) – with 8-cylinder engine	Fuel grade: page 23
Windscreen washer incl. headlight cleaning system Intensive cleaning system	approx. 3.5 (6.2 pints) – saloon approx. 6.0 (10.6 pints) – touring approx. 6.0 (10.6 pints) approx. 1.0 (1.8 pints)	Further details: page 150
Cooling system, incl. heater circuit	8.4 (14.8 pints) – BMW 520d 9.2 (16.2 pints) – BMW 525d, 530d 10.5 (18.5 pints) – BMW 520i, 523i, 525i, 530i 12.0 (21.1 pints) – BMW 535i, 540i	Further details: page 152
Engine oil with filter renewal	6.0 (10.6 pints) – BMW 520d 6.5 (11.4 pints) – BMW 520i, 523i, 525i, 530i, 525d, 530d 7.5 (13.2 pints) – BMW 535i, 540i	Long-life oil for spark-ignition and diesel engines. Oil grades: page 152
Manual gearbox, automatic transmission and final drive	–	Permanently filled, no oil changes



Initial overview

Controls in detail

Operation, maintenance

Minor repairs

Technical data

Index

Overview

Controls

Maintenance



Minor repairs

Data

Keywords

Everything from A to Z







A

ABS (Anti-lock brake system) 18, 143
Acceleration 189
Accessories 9
Activated charcoal filter 119
Active seat 53
Adding engine oil 151 
Air conditioning 111, 116
 demisting windows 113
Air distribution 112, 116
Air pressure 24, 145
Air supply 112, 116
Air vents 114
Airbags 18, 60
Alarm system 32, 44
Antifreeze, radiator 152 
 using 152 
Anti-lock brake system (ABS) 18, 143
Anti-theft system 44
Aquaplaning 142, 145
Arrival time, estimated 91
ASC+T (Automatic Stability Control plus Traction) 18, 102
Ashtray 126, 127
AUC (Automatic Recirculated Air Control) 117
Automatic air conditioning 114, 116



Automatic driving lights control 107
Automatic Recirculated Air Control (AUC) 117
Automatic Stability Control plus Traction (ASC+T) 18, 102
Automatic steering wheel adjustment 57
Automatic transmission with Steptronic 18, 70
Auxiliary heater 112, 118, 120
 remote control 121
Average fuel consumption 84, 91
Average speed 84, 92
Axle loads 185

B

Battery 171
 charge indicator light 17
 charging 171
 recharging 171 
Beam height adjustment, headlights 108
Beam throw adjustment 108
Biodiesel 23
Blower 112, 116
BMW Active seat 53
BMW Comfort seat 51

Bonnet opening 148 
 unlocking 148 
Boot lid remote operation 36
Bottle holders, see Drinks can holders
Brake fluid 154
 adding 154 
Brake hydraulics 17
Brake lights, changing bulbs 164 
Brakes 144
Breakdown service 173 
Bulb changing 161 

C

Call charges 99
Call duration 99
Can holders, see Drinks can holders
Car battery 171
Car Memory 64
Car phone 125
Central locking 32
 button 37
Centre brake light 165
Check Control 81
 button 81
Checking engine oil level 150 
Child restraint systems 61
Child seat 61
Childproof door locks 64
Childproof safety switch 46
Cigarette lighter 126
Clock 86
Clock, see also on-board computer Owner's Handbook
CO₂ emissions 181
Code 92
 activating 92
 deactivating 92
 emergency deactivation 93
 selecting 92
Code, see also operating instructions for on-board computer
Cold starting 67
Comfort seat 51
Compartments in load area 133
Computer 83, 84, 89
Consumption 84, 91
Controls 12
Convenient operation of windows and sliding/tilt sunroof 33, 35
Convenient starting 67
Coolant 152
 adding 153 
Coolant thermometer 79

Cooling, maximum 117
 Copyright 4
 Cruise control 75
 Cup holder, see Drinks can holders

D

Date
 calling up 86
 changing 86
 Date, see also on-board computer Owner's Handbook
 Daytime dipped headlights 107
 DBC (Dynamic Brake Control) 18, 104
 Deadlock 44
 Defogging windows 113
 Defrost setting 113, 116
 Defrosting windows 113, 116
 Dialling
 by input of phone number 98
 by name 96
 by TOP-8 96
 via one-touch dialling number 97
 Diesel fuel 23
 Digital clock 86

Digital clock, see also on-board computer Owner's Handbook
 Dimensions 183
 Dipped headlights 107
 automatic 107
 Dipstick 150
 Disc brakes 144
 Displacement 180
 Display lighting 108
 Displays 13, 15
 Distance 90
 Door keys 32
 Drinks can holders 126
 Driving area 12
 Driving hints
 aquaplaning 142
 brakes 142
 rear-window shelf 142
 water on roads 142
 Driving lights control, automatic 107
 Driving on left/right 156
 DSC (Dynamic Stability Control) 18, 102
 Dust caps, tyre valves 170
 Dynamic Brake Control (DBC) 18, 104
 Dynamic Stability Control (DSC) 18, 102

E

Eco-diesel 23
 EDC (Electronic Damping Control) 104
 Electric mirror heating 58
 Electric steering wheel adjustment 57
 Electric window lifts 45
 Electrical consumer failure 172
 Electronic Damping Control (EDC) 104
 Emergency call 95
 Emergency operation doors 33
 fuel filler flap 22
 luggage compartment 38
 sunroof 48
 tailgate 39
 Energy Control 78
 Engine compartment 149
 opening 148
 unlocking 148
 Engine coolant 152
 adding 153
 Engine data 180
 Engine oil 150
 checking level 150
 consumption 150
 grades 152
 level 17, 18

pressure 17
 viscosity 152
 Engine size 180
 Engine, starting 66
 Estimated time of arrival 91

F



Failure displays 81
 Failure indications 81
 False alarms, avoiding 45
 Filling capacities 191
 Flashing turn indicator changing bulb 162, 164
 Flashing turn indicator repeaters 19
 Flat battery 173
 Flooding 142
 Fog lights 109
 changing bulb 163
 Folding rear seat back 128
 Footbrake 144
 Front seat adjustment 49
 Fuel consumption 84, 91
 average 84
 display 78
 figures 181
 Fuel filler flap 22
 Fuel gauge 78
 Fuel grade 23
 Fuel tank 191
 Fuses 172

Everything from A to Z

G

Gearbox, manual-shift 69
Glove box 124
Grilles 111, 114
Gross weight 185
Gross weight limit 185

H

Hand lamp 125
Handbrake 18, 68
Hand-free telephoning 125
Hands-free
 microphone 125
Hazard warning
 flashers 12 
Head airbags 60
Head restraints 53
Headlight adjustment for
 opposite rule of the
 road 156 
Headlight beam throw
 adjustment 108
Headlight cleaning 74
Headlight cleaning
 system 150
Headlight courtesy delay
 feature 107
Headlight flasher 72
Heated rear
 window 112, 118
Heated steering wheel 58

Heating and
 ventilation 111, 114
Heating with engine
 stopped 118
Heavy loads 135
Height 183
Height adjustment, seats 50
High-beam
 headlights 19, 109
 bulb changing 161 
Holders for drinks cans 126
Horn 12
Hydraulic Brake Assistant,
 see DBC

I

Ice warning 77
Ignition key 32
Ignition switch 66
Imprint 4
Independent heater, see
 auxiliary heater
Independent ventilation 120
Inside mirror 59
Inspection 80 
Instrument cluster 13
Instrument cluster switch 72
Instrument lighting 108
Instrument panel 12, 15
Integral child's seats 62
Integrated universal remote
 control 122

Intensive cleaning 73
Intensive cleaning
 system 150
Interior lights 110
 remote control 36
Interior movement
 detector 44
 deactivating 45 
Interior protection 45
Interlock 66
Intermittent wipe 73

J





Jack 167
Jump starting 173

K

Key Memory 64
Keys 32
Kick-down 71
Knock control 23





L

Lashing down loads 43, 136
Lashing points 43
Length 183
Licence plate lights
 changing bulb 166 
Light switch 107
LIGHTS ON warning 107
Limit 89

Load area 38, 132
 capacity 185
 net 43
 opening separately 38
Load area cover,
 touring 132
Loads 135
 securing 135
Lockable wheel studs 170
Long-life oils 152
Low fuel level warning
 light 78
Low-beam headlights 107
 automatic 107
 bulb changing 161 
Luggage
 compartment 38, 43
 capacity 185
 emergency
 operation 38 
 manual operation 38 
 opening from outside 39
 opening separately 38
 releasing in event of
 electrical fault 38 
 remote operation 36
 securing separately 38
Luggage compartment lid
 emergency
 operation 38 

Luggage compartment lid/
tailgate 38
opening from inside the
car 40
remote operation 36
Luggage compartment/load
area lights 110
Lumbar support 51

M

M+S tyres 147
Maintenance 80  155 
Malfunction displays 81
Manual gearbox 69
Manual operation
luggage
compartment 38 
sunroof 48 
tailgate 39 
Master keys 32
Maximum cooling effect 117
Memo 87
Memory 55, 64
MFL (Multifunctional steering
wheel) 20
Micro-filter 113, 119
Microphone, hands-
free 125
MID (Multi-Information
Display) 85
dialling by TOP-8 96

Mirror, anti-glare 59
Mirror, inside, automatic-
dip 59
Mirror memory 55
Mirror, tilt-down 56
Mirrors 58
Mirrors, outside, automatic-
dip 59
Mobile Service 173 
Modifications,
technical 9, 156
Multifunctional steering
wheel (MFL) 20
Multi-Information Display
(MID) 85

N

Non-smoker equipment 127
Nose weight 138
Notebook function 98
Notepad function 98
Nozzles 114

O

OBD socket 157
Octane numbers 23
Odometer 77
Oil additives 151
Oil change intervals, see
Service booklet
Oil grades 152 



Oil level 150 
checking 150
Oil level warning light 18
Oil pressure, indicator
light 17
Oil Service 80
Old batteries 171
On-board computer
remote control 93
On-board computer, see
also separate on-board
computer Owner's
Handbook
One-touch dialling 97
Opening and closing from
the inside 37
Opening and closing from
the outside 33
Operating range 84
Outside mirrors 58
Outside temperature
display 77
Outside temperature,
computer display 84

P

















Park Distance Control
(PDC) 101
Parking aid 101
Parking brake 68
Parking lights 109
changing bulb 162 

PDC (Park Distance
Control) 101
Performance 180, 189
Petrol 23
Pollen 119
Pollen filter 113
Power socket 127
Preheater operation, see
also on-board computer
Owner's Handbook
Preheating 19, 67
Protective net 132
Punctures 145, 167 

R



Radio-operated keys 32
Rain sensor 73
Range 84
Range before refuelling 91
Rapeseed oil methyl
ester 23
RDC (Tyre Pressure
Control) 105
Rear driving lights
changing bulbs 164 
Rear fog lights 109
changing bulb 164 
Rear light 164
Rear lighting system 164
changing bulbs 164 
Rear seat back, folding 128



Everything from A to Z





- Rear window
 - cleaning 74
 - heated 118
 - heating 112
 - opening 40
 - renewing wiper blade 160 
 - washer 74
- Rear-seat area
 - ventilation 119
- Reception signal 99
- Recharging battery 171 
- Recirculated air
 - mode 112, 117
- Reclining seat 49
- Refuelling 22
- Reminder signal 87
- Remote control 34
 - auxiliary heater 121
 - integrated universal 122
 - keys 32
 - on-board computer 93
- Remote control for
 - independent heater
 - changing battery 166 
 - new transmitter 166 
- Renewing fuses 172 
- Replacement keys 32
- Residual heat 118
- Restraint system 61
- Retaining straps 43
- Retreaded tyres 146
- Reverse 69
- Reversing lights 69
- Revolution counter 78
- Rims 146
- Roller sunblinds 119
- Roller-blind cover,
 - touring 132
- Roof load 185
- Roof rack 136
- Rule of the road
 - headlight adjustment 156 
- Running in 142
- S**
- Safety buttons on doors 37
- Seat back
 - adjustment 50, 51
- Seat belts 54
- Seat, electrically
 - adjusted 51
- Seat heating 56
- Seat height
 - adjustment 50, 51
- Seat, mechanical 50
- Seat memory 55
- Seats, adjusting 49
- Selecting desired memory settings 64
- Selector lever, automatic
 - transmission 70
- Self-levelling
 - suspension 19, 105
 - inactive 105 
- Service 80 
- Service Booklet 155
- Service Interval
 - indicator 80, 155
- Servicemobile, see Mobile Service
- Rule of the road
- Side airbags 60
- Side lights 107
 - changing bulb 162 
- Ski bag 129
 - touring 131
- Sliding/tilt sunroof 47
 - convenient operation 33, 35
- Snow chains 147 
- Socket 127
- Socket for On-Board
 - Diagnosis 157
- Spare keys 32
- Spare wheel 168 
- Special oils 152
- Speed 92
- Speed limit 89
- Speedometer 13, 15
- Split rear seat back 128
- Sport seat 50, 51
- Sports steering wheel 20
- Starting difficul-
 - ties 67 , 173, 175 
- Starting the engine 66
- Starting with a flat
 - battery 173 
- Steering lock 66
- Steering wheel
 - automatic adjustment 57
 - heating 58
 - height adjustment 57
 - memory 55
 - with multifunction buttons 20
- Steering wheel, see also multifunctional steering wheel
- Steering wheel, see also sports steering wheel
- Steptronic 70
- Stopping the engine 68
- Stopwatch 87
- Stopwatch, see also on-board computer Owner's Handbook
- Storage compartments 125
- Storage space 125
- Stratified temperatures 118
- Sun roller blind 119
- Sunroof 47
 - closing after electrical fault 48 
 - electrical failure 48 







Supplementary functions for
 telephone operation 99
 Switching off the interior
 protection 36 
 Switch-on times, input 88
 Symbols 8

T

Tailgate
 emergency
 operation 42 
 opening from inside the
 car 40
 opening from outside 39
 releasing in event of
 electrical fault 42 
 securing separately 38
 Technical
 modifications 9, 156
 Telephone 125
 activating controls 95
 additional functions 99
 dialling by name 96
 dialling by phone
 number 98
 notepad function 98
 preparation 125
 Telephone operation 94
 Telephone operation via
 MID 94
 dialling by input of phone
 number 97, 98

dialling by name 95
 dialling via one-touch
 dialling number 97
 emergency call 95
 notebook function 98
 supplementary
 functions 99
 Telltale lights 17 
 Temperature, adjusting 112
 Temperature
 control 113, 116
 Temperature display, engine
 coolant 79
 Theftproof wheel studs 170
 Thigh support,
 adjusting 50, 51
 Third brake light 165
 Through-loading
 system 128
 Tilt alarm sensor 36, 45
 deactivating 36 
 Tilt-down mirror 56
 Time
 calling up 86
 changing 86
 Timer 86
 Timer, see also on-board
 computer Owner's
 Handbook
 Toolkit 160 
 Top speed 189
 TOP-8 96

Torch 125
 Torque 180
 touring
 compartments in load
 area 133
 folding rear seat back 132
 lashing down loads 136
 load area 132
 net, protective 132
 opening rear window 40
 rear window washer 74
 releasing fuel filler flap if an
 electrical defect
 occurs 22 
 releasing tailgate in event
 of electrical fault 39 
 securing load 135
 ski bag 131
 Towbar
 downthrust 138, 185
 Towing away 175 
 Towing eyes 175 
 Tow-starting 175 
 Track 183
 Traction control, see ASC+T
 and/or DSC 102
 Trailer loads 185
 Trailer nose weight 185
 Trailer tow hitch, cover
 flap 137
 Transmission 70

Transmitter, new, for
 independent heater
 remote control 166 
 Trip distance recorder 77
 Turn indicators 72
 Turning circle 183
 Tyre
 changing 167 
 condition 145
 damage 145 
 failures 167 
 tread 145
 Tyre Pressure Control
 (RDC) 105
 Tyre pressures 145 
 checking 24 
 Tyre wear indicators 145

U

Unladen weight 185

V

Vacuum cleaner,
 connecting 127
 Ventilation 113, 114
 draught-free 113, 118
 grilles 111
 independent 120
 rear-seat area 113
 Vents, ventilation 114
 Viscosity 152

Everything from A to Z

Voice input 20

see also separate Owner's Handbook

W

Warm feet, cool head 113

Warning displays 81

Warning light

"Fasten seat belts" 18

low fuel level 78

Warning signals 81 

Warning triangle 21 

Washer fluid, adding 150 

Washer reservoir,
refilling 150 

Water on road 142

Wear indicators in tyres 145

Weights 185

Wheel covers 168

Wheel stud wrench 168 

Wheel studs 168

lockable 170

Wheelbase 183

Wheel-changing 167

Wheels and tyres 146

Width 183

Window lifts 45

Window safety switch 46

Windows 45, 116

convenient

operation 33, 35

defrosting 113 

Windscreen washer 73

Windscreen washer
reservoir, refilling 150 

Windscreen wiper blades,
renewing 160 

Windscreen wipers 73

Winter tyres 147

Winter-grade diesel 23

Wiper blades,
renewing 160 

Wipers 73

Working on engine 148 

X

Xenon headlights 108, 162

Refuelling stop

BMW recommends 

So that you always have access to the data you need when refuelling, you are recommended to add the relevant information to the table shown here. Use the index to find the pages with the information that is applicable to your car.

Fuel

Designation	
-------------	--

Enter your preferred grade of fuel here.

Engine oil

Grade	
-------	--

The quantity of oil between the two dipstick marks is approx. 1 litre (1.75 pints).

Tyre pressures

	Summer tyres		Winter tyres	
	front	rear	front	rear
Up to 4 persons				
5 persons or 4 plus luggage				

More about BMW

www.bmw.com



Sheer Driving
Pleasure

